

PRODUCT FEATURES

- Ultrafast Recovery Time
- Soft Recovery Characteristics
- Low Recovery Loss
- Low Forward Voltage
- High Surge Current Capability
- Low Leakage Current

APPLICATIONS

- Freewheeling, Snubber, Clamp
- Inversion Welder
- PFC
- Plating Power Supply
- Ultrasonic Cleaner and Welder
- Converter & Chopper
- UPS

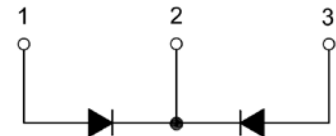
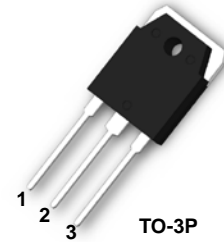

DESCRIPTION

FRED from MacMic utilizes advanced processing techniques to achieve ultrafast recovery times and higher forward current. Its soft recovery characteristics and high reliability suit for wide industrial applications.

ABSOLUTE MAXIMUM RATINGS

T_C=25°C unless otherwise specified

Symbol	Parameter	Test Conditions	Values	Unit
V _R	Maximum D.C. Reverse Voltage		220	V
V _R RM	Maximum Repetitive Reverse Voltage		220	V
I _{F(AV)}	Average Forward Current	T _C =110°C, Per Diode	10	A
		T _C =110°C, Per Package	20	A
I _{F(RMS)}	RMS Forward Current	T _C =110°C, Per Diode	14	A
I _{FSM}	Non-Repetitive Surge Forward Current	T _J =45°C, t=10ms, 50Hz, Sine	100	A
P _D	Power Dissipation		83	W
T _J	Junction Temperature		-40 to +150	°C
T _{STG}	Storage Temperature Range		-40 to +150	°C
Torque	Module-to-Sink	Recommended (M3)	1.1	N-m
R _{θJC}	Thermal Resistance	Junction-to-Case	1.5	°C/W
Weight			5.2	g

ELECTRICAL CHARACTERISTICS

T_C=25°C unless otherwise specified

Symbol	Parameter	Test Conditions	Min.	Typ.	Max.	Unit
I _{RM}	Reverse Leakage Current	V _R =220V	--	--	10	µA
		V _R =220V, T _J =125°C	--	--	10	mA
V _F	Forward Voltage	I _F =10A	--	0.9	1.1	V
		I _F =10A, T _J =125°C	--	--	0.95	V
t _{rr}	Reverse Recovery Time	I _F =1A, V _R =30V, di _F /dt=-200A/µs	--	17	--	ns
t _{rr}	Reverse Recovery Time	V _R =100V, I _F =10A	--	32	--	ns
I _R RM	Max. Reverse Recovery Current	di _F /dt=-200A/µs, T _J =25°C	--	2.1	--	A
t _{rr}	Reverse Recovery Time	V _R =100V, I _F =10A	--	45	--	ns
I _R RM	Max. Reverse Recovery Current	di _F /dt=-200A/µs, T _J =125°C	--	5	--	A

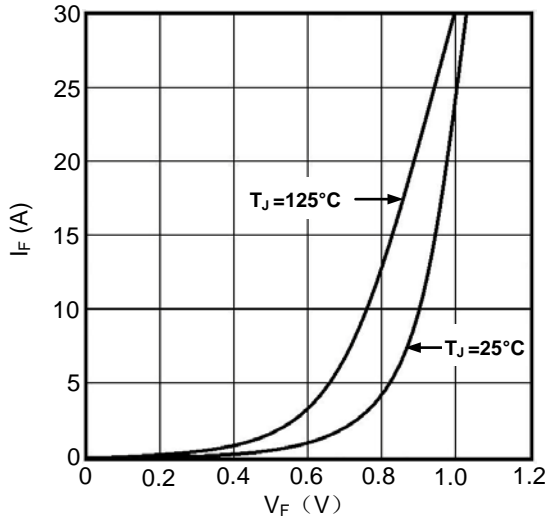

Fig1. Forward Voltage Drop vs Forward Current

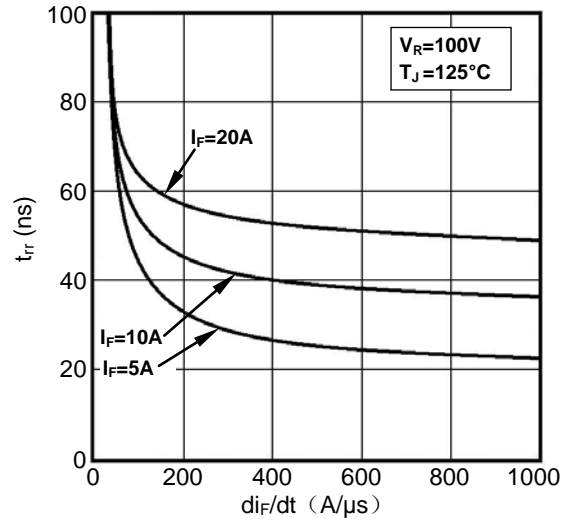

Fig2. Reverse Recovery Time vs di_F/dt

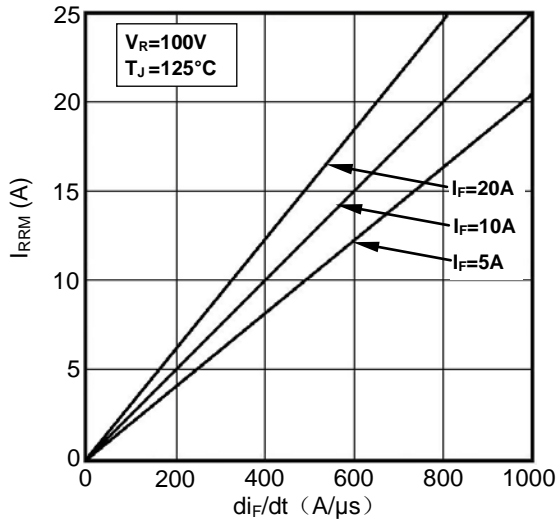

Fig3. Reverse Recovery Current vs di_F/dt

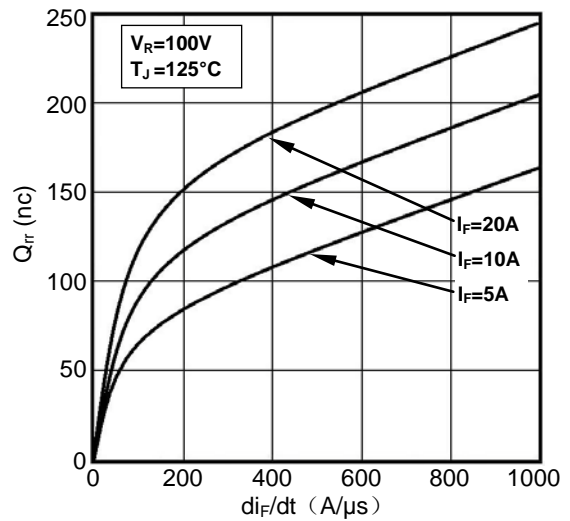

Fig4. Reverse Recovery Charge vs di_F/dt

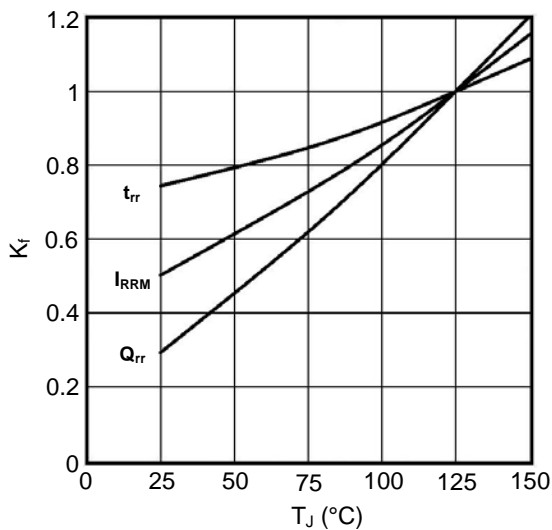

Fig5. Dynamic Parameters vs Junction Temperature

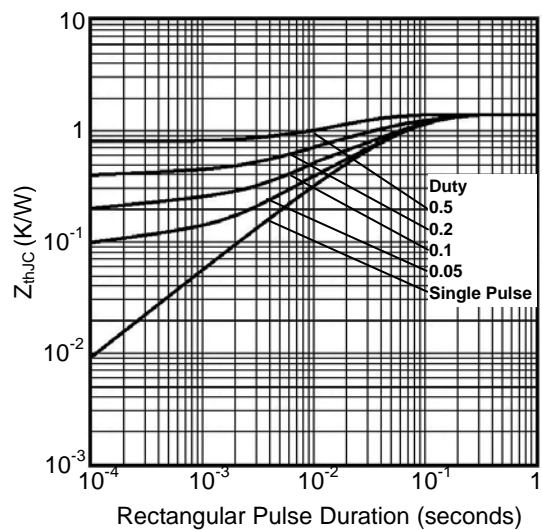

Fig6. Transient Thermal Impedance

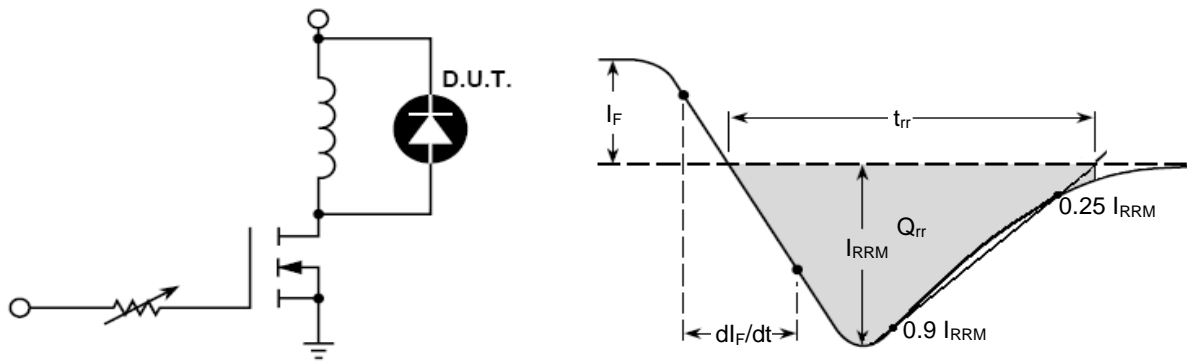
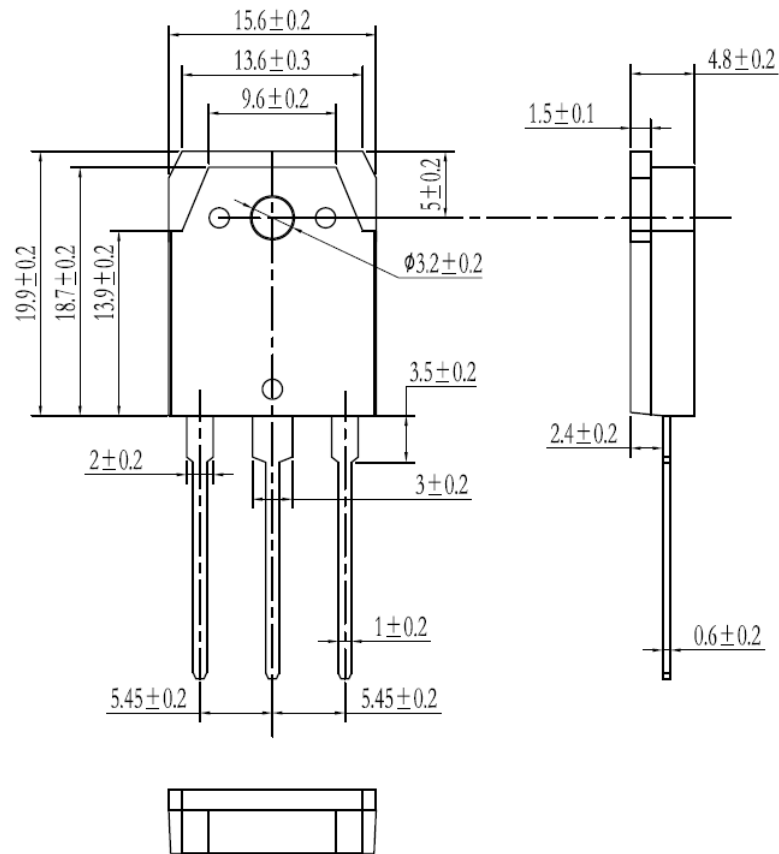

Fig7. Diode Reverse Recovery Test Circuit and Waveform



Dimensions in Millimeters
Fig8. Package Outline