

## PRODUCT FEATURES

- Ultrafast Recovery Time
- Low Recovery Loss
- Soft Reverse Recovery Characteristics
- Low Leakage Current
- Low Forward Voltage
- High Surge Current Capability

## APPLICATIONS

- Freewheeling, Snubber, Clamp
- Inversion Welder
- PFC
- Plating Power Supply
- Ultrasonic Cleaner and Welder
- Converter & Chopper
- UPS

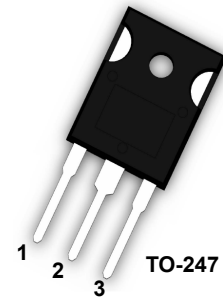

## DESCRIPTION

FRED from MacMic utilizes advanced processing techniques to achieve ultrafast recovery times and higher forward current. Its soft recovery characteristics and high reliability suit for wide industrial applications.

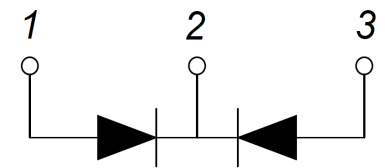

## ABSOLUTE MAXIMUM RATINGS

$T_C = 25^\circ\text{C}$  unless otherwise specified

Symbol	Parameter/Test Conditions		Values	Unit
$V_R$	Maximum D.C. Reverse Voltage		220	V
$V_{RRM}$	Maximum Repetitive Reverse Voltage			
$I_{F(AV)}$	Average Forward Current	$T_C = 110^\circ\text{C}$ , Per Diode	10	A
		$T_C = 110^\circ\text{C}$ , Per Package	20	
$I_{F(RMS)}$	RMS Forward Current	$T_C = 110^\circ\text{C}$ , Per Diode	14	
$I_{FSM}$	Non-Repetitive Surge Forward Current	$T_J = 45^\circ\text{C}$ , $t = 10\text{ms}$ , 50Hz, Sine	100	
$P_D$	Power Dissipation		83	W
$T_J$	Junction Temperature		-55 to +150	$^\circ\text{C}$
$T_{STG}$	Storage Temperature Range		-55 to +150	$^\circ\text{C}$
<b>Torque</b>	Module-to-Sink	Recommended (M3)	1.1	N·m
$R_{th(J-C)}$	Junction-to-Case Thermal Resistance, Per Diode		1.5	$^\circ\text{C/W}$
<b>Weight</b>			5.2	g

## ELECTRICAL CHARACTERISTICS

$T_C = 25^\circ\text{C}$  unless otherwise specified

Symbol	Parameter/Test Conditions		Min.	Typ.	Max.	Unit
$I_{RM}$	Maximum Reverse Leakage Current	$V_R = 220\text{V}$			10	$\mu\text{A}$
		$V_R = 220\text{V}$ , $T_J = 125^\circ\text{C}$			10	mA
$V_F$	Forward Voltage	$I_F = 10\text{A}$		0.9	1.1	V
		$I_F = 10\text{A}$ , $T_J = 125^\circ\text{C}$			0.95	
$t_{rr}$	Reverse Recovery Time ( $I_F = 1\text{A}$ , $di_F/dt = -200\text{A}/\mu\text{s}$ , $V_R = 30\text{V}$ )			17		ns
$t_{rr}$	Reverse Recovery Time			32		ns
$I_{RRM}$	Maximum Reverse Recovery Current	$I_F = 10\text{A}$ , $V_R = 100\text{V}$ , $di_F/dt = -200\text{A}/\mu\text{s}$		2.1		A
$t_{rr}$	Reverse Recovery Time			45		ns
$I_{RRM}$	Maximum Reverse Recovery Current	$I_F = 10\text{A}$ , $V_R = 100\text{V}$ , $di_F/dt = -200\text{A}/\mu\text{s}$ , $T_J = 125^\circ\text{C}$		5		A

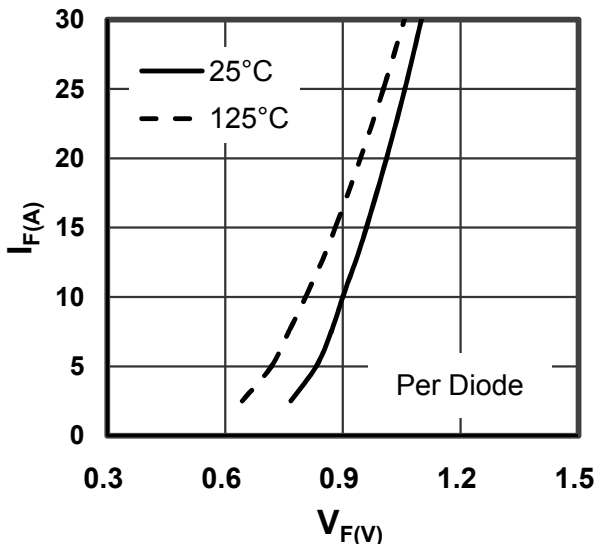

Figure 1. Forward Voltage Drop vs Forward Current

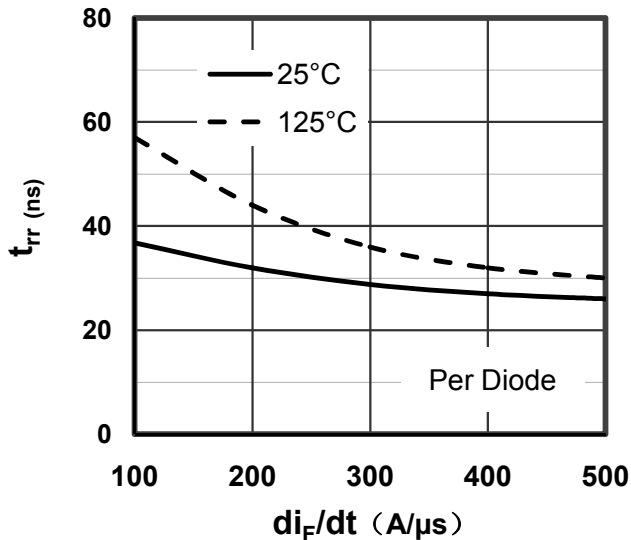

Figure 2. Reverse Recovery Time vs diF/dt

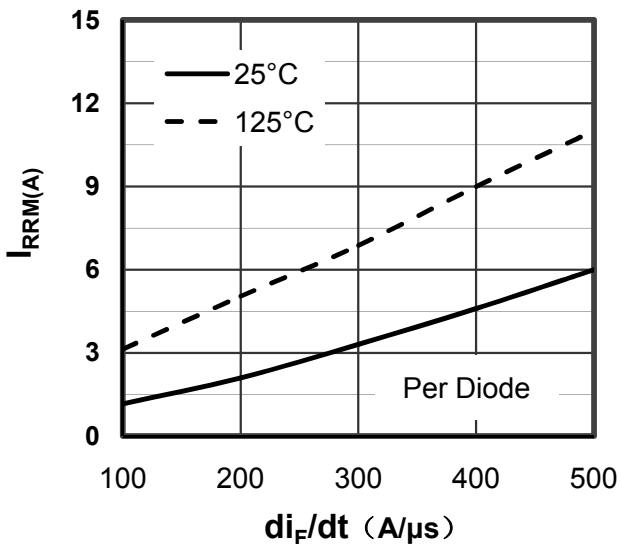

Figure 3. Reverse Recovery Current vs diF/dt

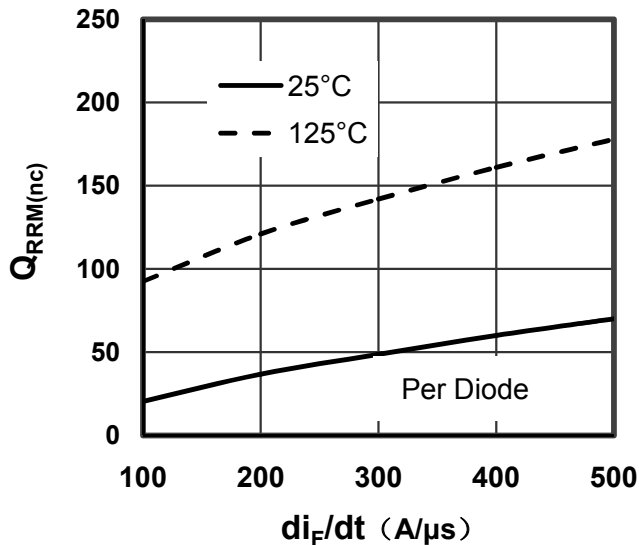

Figure 4. Reverse Recovery Charge vs diF/dt

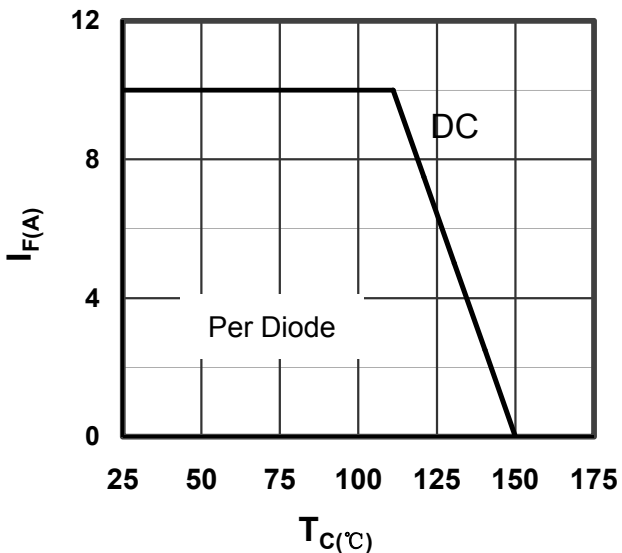

Figure 5. Forward current vs Case temperature

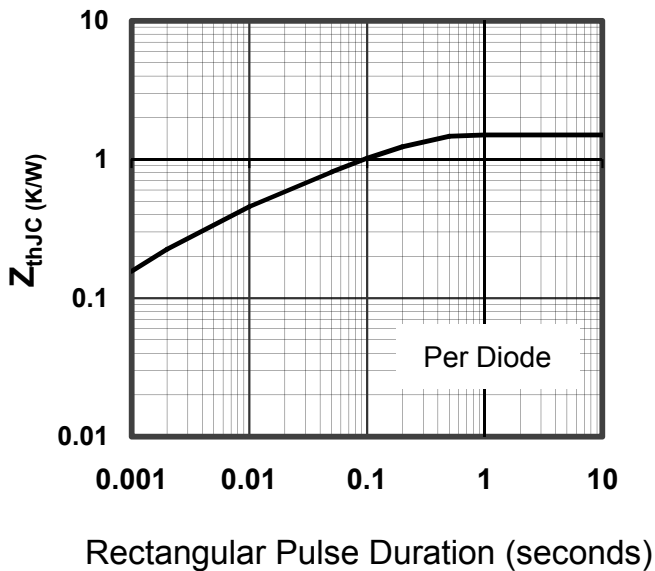

Figure 6. Transient Thermal Impedance

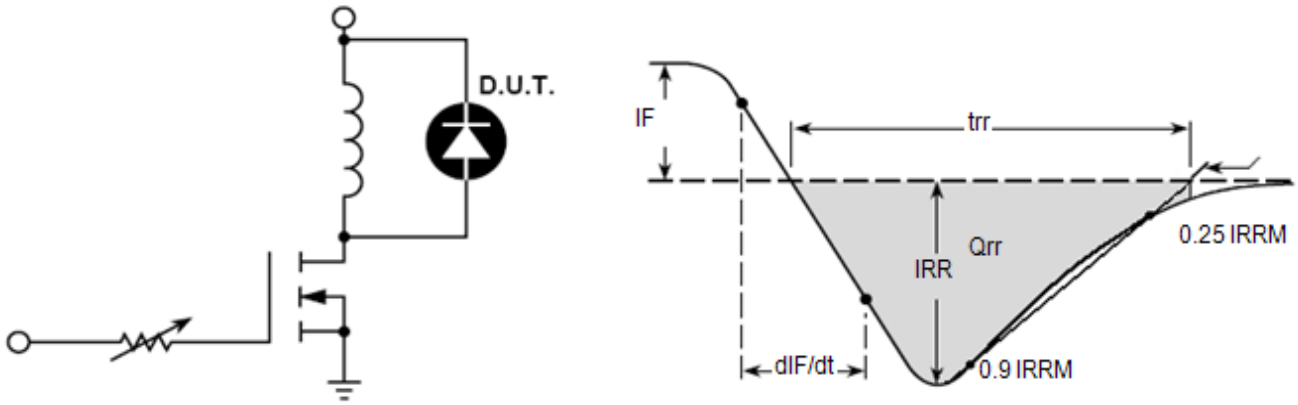
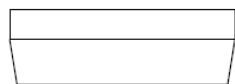
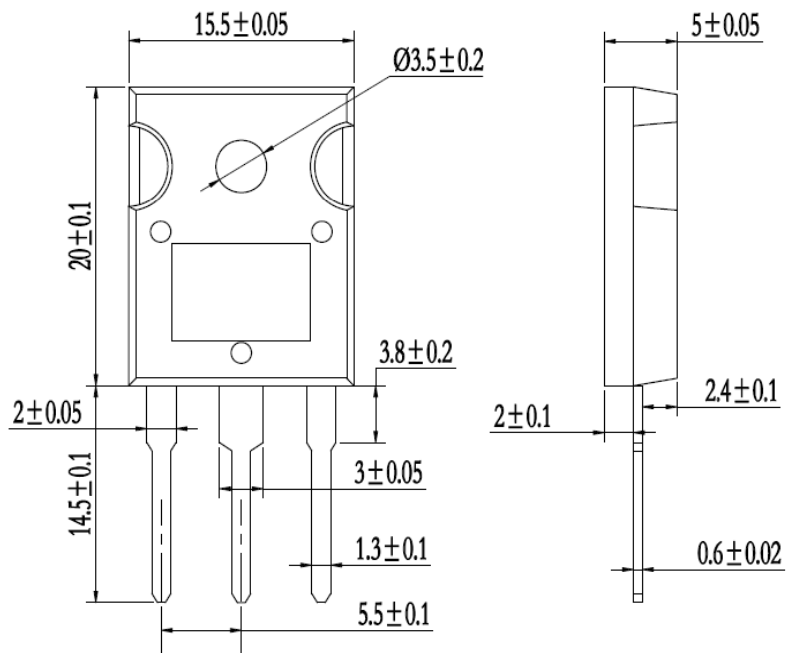

Figure 7. Diode Reverse Recovery Test Circuit and Waveform



Dimensions in Millimeters  
Figure 8. Package Outline