



# MMF150S060B MMF150S060B2B

600V 150A FRED Module  
RoHS Compliant

July 2009 **PRELIMINARY**

## PRODUCT FEATURES

- Ultrafast Reverse Recovery Time
- Soft Reverse Recovery Characteristics
- Low Reverse Recovery Loss
- Low Forward Voltage
- High Surge Current Capability
- Low Inductance Package

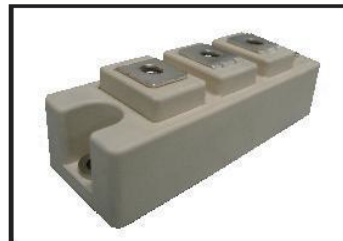

## APPLICATIONS

- Inversion Welder
- Uninterruptible Power Supply (UPS)
- Plating Power Supply
- Ultrasonic Cleaner and Welder
- Converter & Chopper
- Power Factor Correction (PFC) Circuit

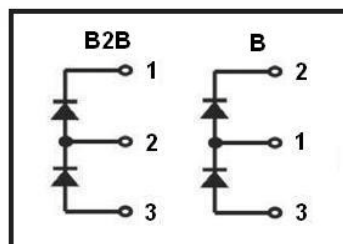

## ABSOLUTE MAXIMUM RATINGS

$T_C=25^{\circ}\text{C}$  unless otherwise specified

| Symbol          | Parameter                            | Test Conditions  | Values      | Unit                        |
|-----------------|--------------------------------------|--|-------------|-----------------------------|
| $V_R$           | Maximum D.C. Reverse Voltage         |  | 600         | V                           |
| $V_{RRM}$       | Maximum Repetitive Reverse Voltage   |  | 600         | V                           |
| $I_{F(AV)}$     | Average Forward Current              | $T_C=110^{\circ}\text{C}$ , Per Diode                    | 150         | A                           |
|                 |                                      | $T_C=120^{\circ}\text{C}$ , 20KHz, Per Module            | 200         | A                           |
| $I_{F(RMS)}$    | RMS Forward Current                  | $T_C=110^{\circ}\text{C}$ , Per Diode                    | 210         | A                           |
| $I_{FSM}$       | Non-Repetitive Surge Forward Current | $T_J=45^{\circ}\text{C}$ , $t=10\text{ms}$ , 50Hz, Sine  | 1500        | A                           |
|                 |                                      | $T_J=45^{\circ}\text{C}$ , $t=8.3\text{ms}$ , 60Hz, Sine | 1600        | A                           |
| $I^2t$          | $I^2t$ (For Fusing)                  | $T_J=45^{\circ}\text{C}$ , $t=10\text{ms}$ , 50Hz, Sine  | 11200       | $\text{A}^2\text{s}$        |
|                 |                                      | $T_J=45^{\circ}\text{C}$ , $t=8.3\text{ms}$ , 60Hz, Sine | 12800       | $\text{A}^2\text{s}$        |
| $P_D$           | Power Dissipation                    |  | 568         | W                           |
| $T_J$           | Junction Temperature                 |  | -40 to +150 | $^{\circ}\text{C}$          |
| $T_{STG}$       | Storage Temperature Range            |  | -40 to +125 | $^{\circ}\text{C}$          |
| $V_{isol}$      | Insulation Test Voltage              | AC, $t=1\text{min}$                                      | 3000        | V                           |
| Torque          | Module-to-Sink                       | Recommended (M6)   | 3~5         | N·m                         |
| Torque          | Module Terminal                      | Recommended (M6)   | 3~5         | N·m                         |
| $R_{\theta JC}$ | Thermal Resistance                   | Junction-to-Case   | 0.22        | $^{\circ}\text{C}/\text{W}$ |
| Weight          |                                      |  | 155         | g                           |

**MMF150S060B**  
**MMF150S060B2B**

**ELECTRICAL CHARACTERISTICS**

$T_C=25^{\circ}\text{C}$  unless otherwise specified

| Symbol    | Parameter                     | Test Conditions   | Min. | Typ. | Max. | Unit |
|-----------|-------------------------------|---|------|------|------|------|
| $I_{RM}$  | Reverse Leakage Current       | $V_R=600\text{V}$   | --   | --   | 1    | mA   |
|           |                               | $V_R=600\text{V}, T_J=125^{\circ}\text{C}$                        | --   | --   | 5    | mA   |
| $V_F$     | Forward Voltage               | $I_F=150\text{A}$   | --   | 1.15 | 1.60 | V    |
|           |                               | $I_F=150\text{A}, T_J=125^{\circ}\text{C}$                        | --   | --   | 1.45 | V    |
| $t_{rr}$  | Reverse Recovery Time         | $I_F=1\text{A}, V_R=30\text{V}, di_F/dt=-200\text{A}/\mu\text{s}$ | --   | 50   | --   | ns   |
| $t_{rr}$  | Reverse Recovery Time         | $V_R=300\text{V}, I_F=150\text{A}$                                | --   | 130  | --   | ns   |
| $I_{RRM}$ | Max. Reverse Recovery Current | $di_F/dt=-200\text{A}/\mu\text{s}, T_J=25^{\circ}\text{C}$        | --   | 14   | --   | A    |
| $t_{rr}$  | Reverse Recovery Time         | $V_R=300\text{V}, I_F=150\text{A}$                                | --   | 220  | --   | ns   |
| $I_{RRM}$ | Max. Reverse Recovery Current | $di_F/dt=-200\text{A}/\mu\text{s}, T_J=125^{\circ}\text{C}$       | --   | 22   | --   | A    |

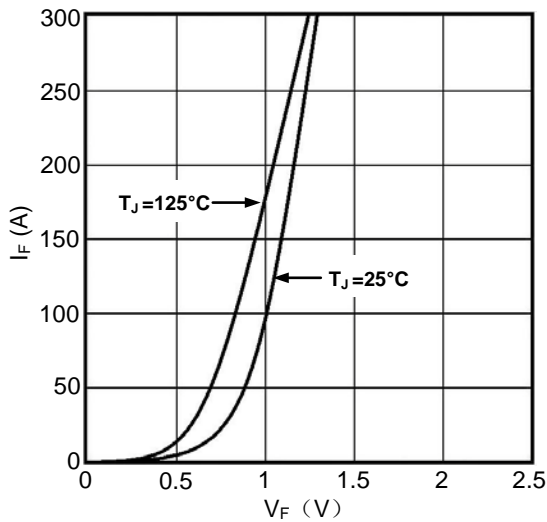

Figure1. Forward Voltage Drop vs Forward Current

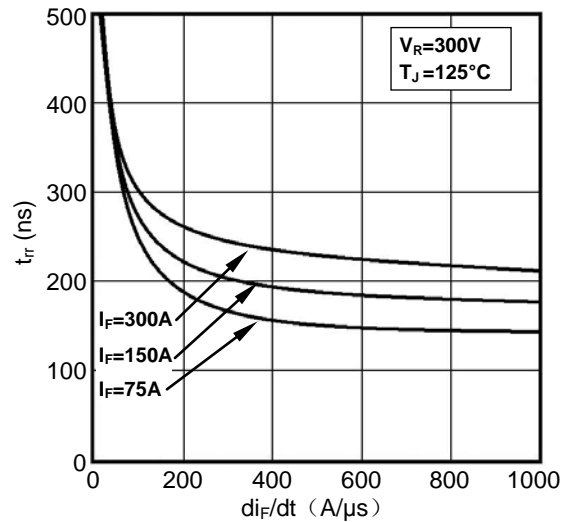

Figure2. Reverse Recovery Time vs  $di_F/dt$

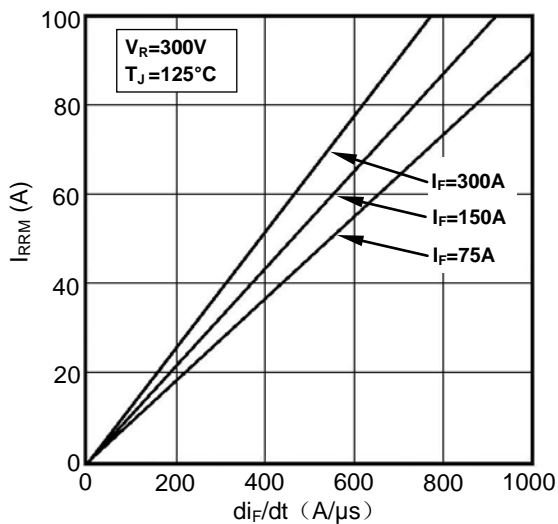

Figure3. Reverse Recovery Current vs  $di_F/dt$

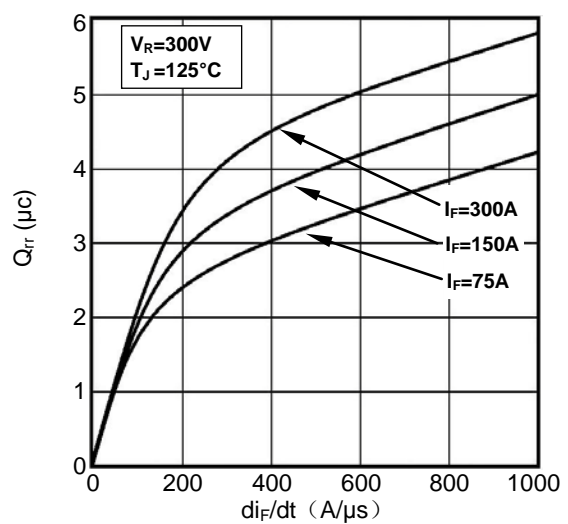

Figure4. Reverse Recovery Charge vs  $di_F/dt$

**MMF150S060B**  
**MMF150S060B2B**

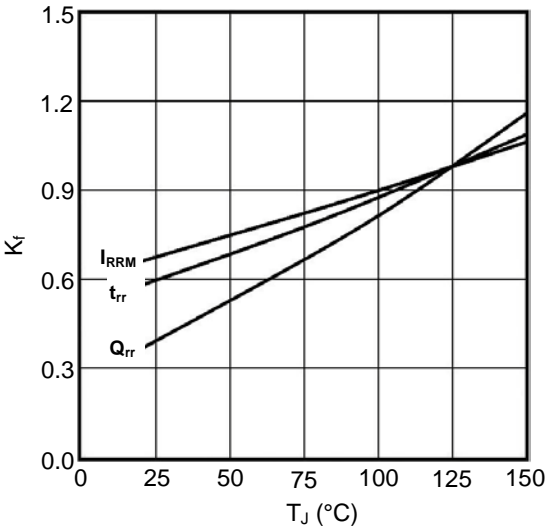

Figure5. Dynamic Parameters vs Junction Temperature

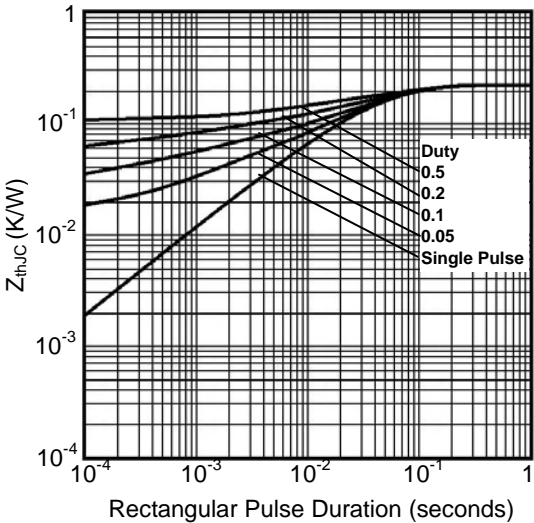
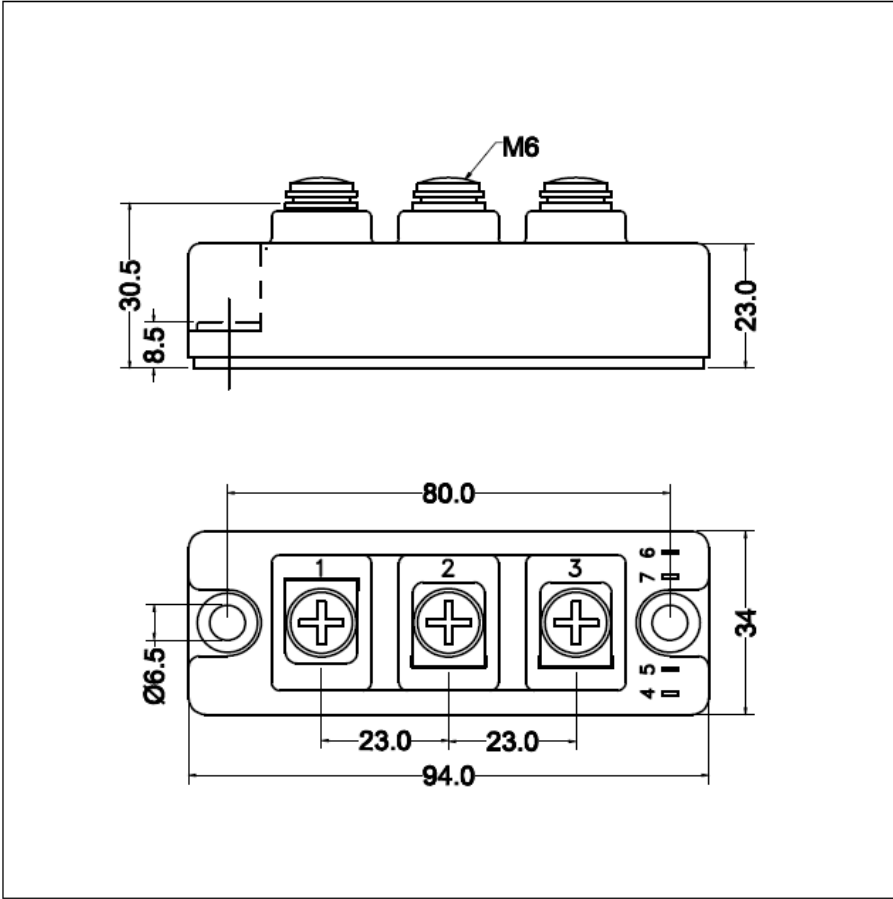

Figure6. Transient Thermal Impedance



Dimensions (mm)  
 Figure7. Package Outline