

PRODUCT FEATURES

- Ultrafast Recovery Time
- Low Recovery Loss
- Low Forward Voltage
- Low Leakage Current
- Low Inductance Package



APPLICATIONS

- Inversion Welder
- Uninterruptible Power Supply
- Plating Power Supply
- Ultrasonic Cleaner and Welder
- Converter & Chopper
- PFC

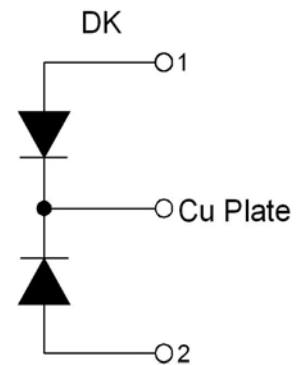

ABSOLUTE MAXIMUM RATINGS

$T_C = 25^\circ\text{C}$ unless otherwise specified

Symbol	Parameter/Test Conditions		Values	Unit
V_R	Maximum D.C. Reverse Voltage		400	V
V_{RRM}	Maximum Repetitive Reverse Voltage			
$I_{F(AV)}$	Average Forward Current	$T_C = 110^\circ\text{C}$, Per Diode	150	A
		$T_C = 110^\circ\text{C}$, Per Module	300	
$I_{F(RMS)}$	RMS Forward Current	$T_C = 110^\circ\text{C}$, Per Diode	210	
I_{FSM}	Non-Repetitive Surge Forward Current	1/2 Cycle, 50Hz, Sine	2000	
		1/2 Cycle, 60Hz, Sine	2100	
I^2t	For Fusing	$T_J = 45^\circ\text{C}$, $t = 10\text{ms}$, 50Hz, Sine	20000	A ² S
		$T_J = 45^\circ\text{C}$, $t = 8.3\text{ms}$, 60Hz, Sine	18300	
P_D	Power Dissipation		500	W
T_J	Junction Temperature		-40 to +150	$^\circ\text{C}$
T_{STG}	Storage Temperature Range		-40 to +125	$^\circ\text{C}$
Torque	Module-to-Sink	Recommended (M6)	3~4.7	N.m
	Module Electrodes	Recommended (M6)	3~4.7	N.m
$R_{th(J-C)}$	Junction-to-Case Thermal Resistance		0.25	K/W
Weight			92	g

ELECTRICAL CHARACTERISTICS

$T_C = 25^\circ\text{C}$ unless otherwise specified

Symbol	Parameter/Test Conditions		Min.	Typ.	Max.	Unit
I_{RM}	Maximum Reverse Leakage Current	$V_R = 400\text{V}$			0.5	mA
		$V_R = 400\text{V}, T_J = 125^\circ\text{C}$			1	
V_F	Forward Voltage	$I_F = 150\text{A}$		1.20	1.45	V
		$I_F = 150\text{A}, T_J = 125^\circ\text{C}$		1.10		
t_{rr}	Reverse Recovery Time ($I_F = 1\text{A}, di_F/dt = -200\text{A}/\mu\text{s}, V_R = 30\text{V}$)			53		ns
t_{rr}	Reverse Recovery Time	$I_F = 150\text{A}, V_R = 200\text{V},$		95		ns
I_{RRM}	Maximum Reverse Recovery Current	$di_F/dt = -200\text{A}/\mu\text{s}$		12		A
t_{rr}	Reverse Recovery Time	$I_F = 150\text{A}, V_R = 200\text{V},$		165		ns
I_{RRM}	Maximum Reverse Recovery Current	$di_F/dt = -200\text{A}/\mu\text{s}, T_J = 125^\circ\text{C}$		20		A

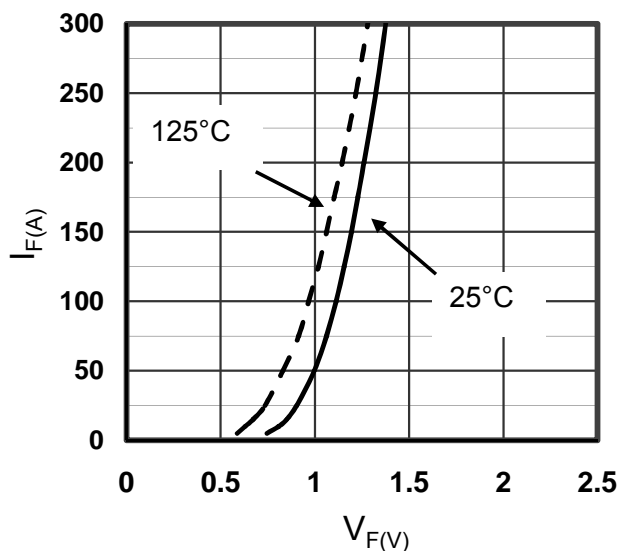

Figure1. Forward Voltage Drop vs Forward Current

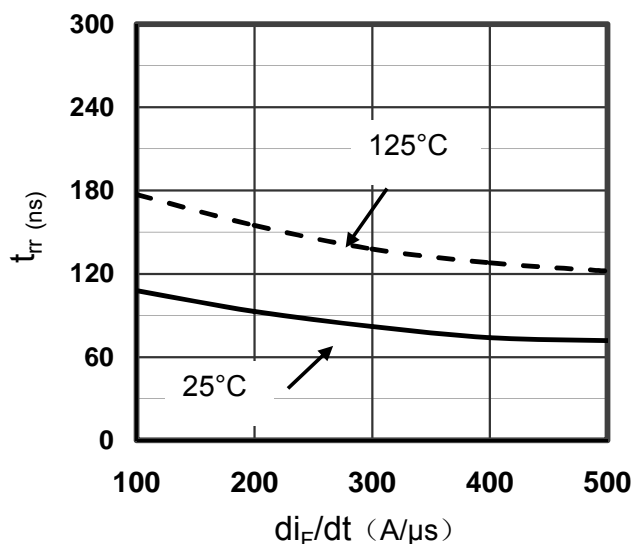

Figure2. Reverse Recovery Time vs diF/dt

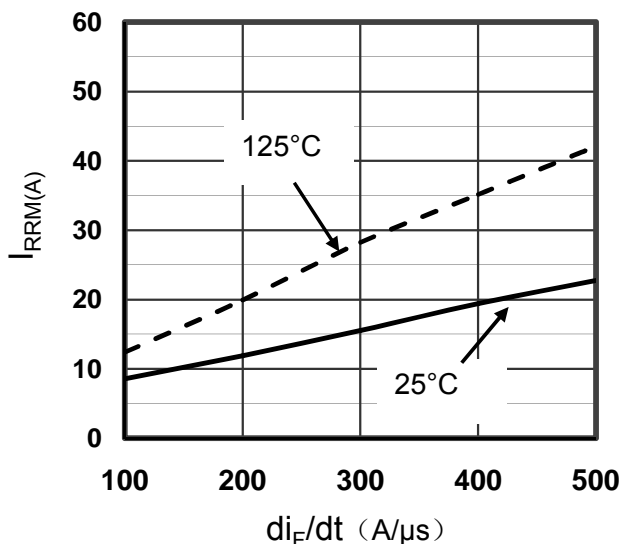

Figure3. Reverse Recovery Current vs diF/dt

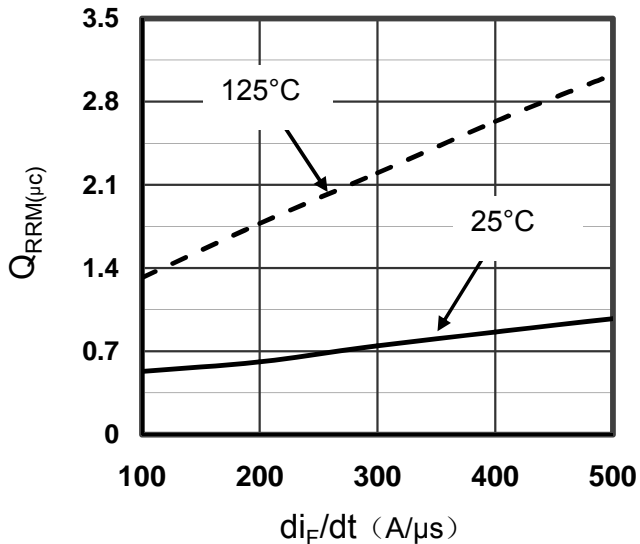

Figure4. Reverse Recovery Charge vs diF/dt

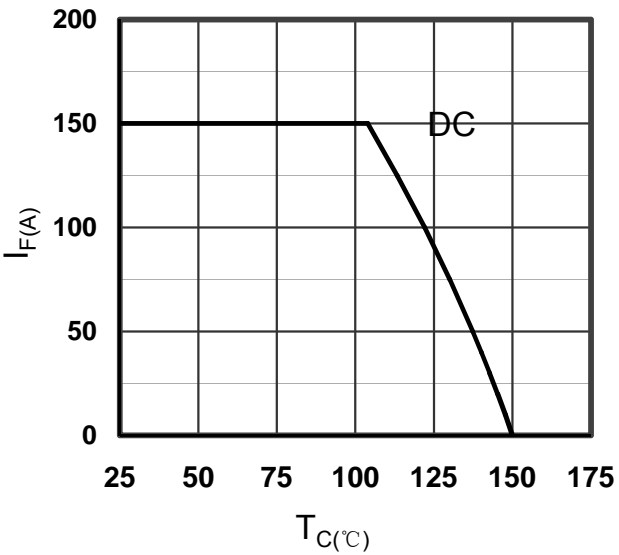

Figure5. Forward current vs. Case temperature

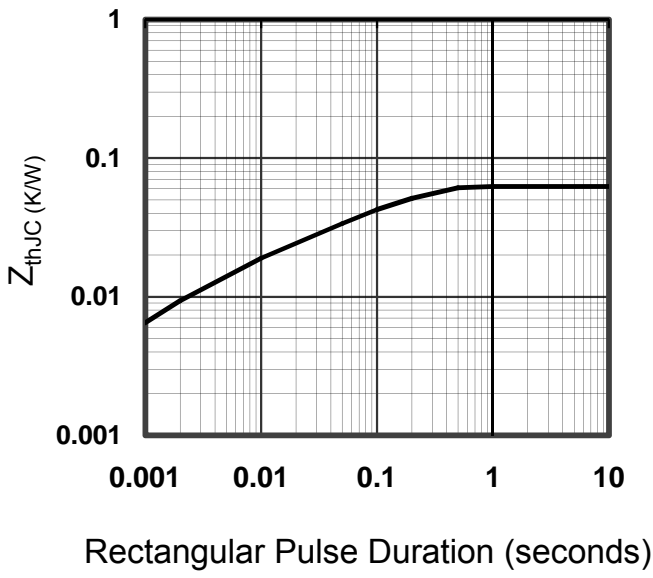
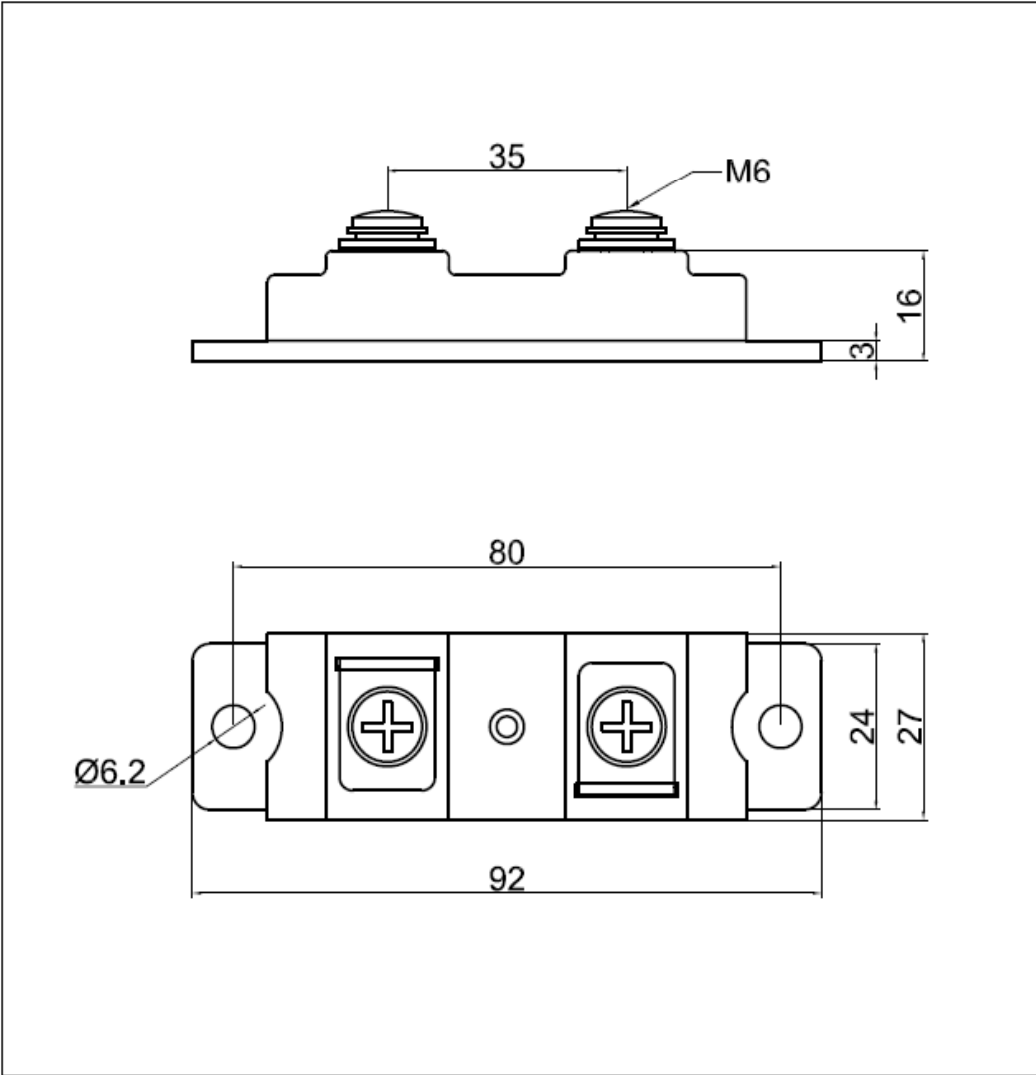

Figure6. Transient Thermal Impedance



Dimensions in Millimeters and (Inchs)
Figure7. Package Outline