

PRODUCT FEATURES

- Electrically Isolated by DBC Ceramic
- High Surge Current Capability
- Low Inductance Package

APPLICATIONS

- DC Motor Control and Drives
- Battery Charges ,Heater controls,Light dimmers
- Static switches

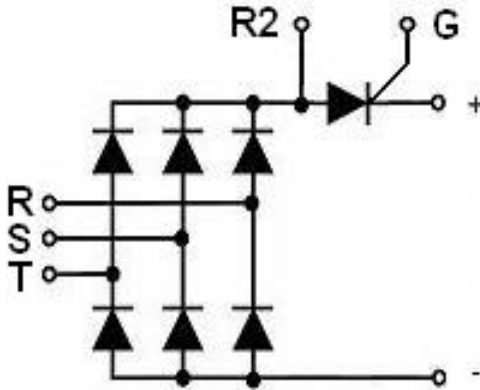

MAXIMUM VOLTAGE RATINGS

$T_C = 25^\circ\text{C}$ unless otherwise specified

Module Type	V_{RRM}/V_{DRM}	V_{RSM}	Unit
MMK200T160UX6J	1600	1700	V

ABSOLUTE MAXIMUM RATINGS (Thyristor)

Symbol	Parameter/Test Conditions		Values	Unit
$I_{T(AV)}$	Average On-State Current	Single phase, half wave, 180°conduction, $T_c = 80^\circ\text{C}$	200	A
$I_{T(RMS)}$	R.M.S. On-State Current		310	
I_{TSM}	Non-Repetitive Surge On-State Current	1/2 cycle, 50/60HZ, peak value, $T_c = 45^\circ\text{C}$	4500/4800	
I^2t	I^2t (For Fusing)	1/2 cycle, 50/60HZ, peak value, $T_c = 45^\circ\text{C}$	100/95	KA ² S
T_J	Junction Temperature(Thyristor)		-40 to +125	°C

ABSOLUTE MAXIMUM RATINGS (Diode)

Symbol	Parameter/Test Conditions		Values	Unit
$I_{F(AV)}$	Average Forward Current	Single phase, half wave, 180°conduction, $T_c = 95^\circ\text{C}$	200	A
$I_{F(RMS)}$	R.M.S. Forward Current		310	
I_{FSM}	Non-Repetitive Surge Forward Current	1/2 cycle, 50/60HZ, peak value, $T_c = 45^\circ\text{C}$	2600/2800	
I^2t	For Fusing	1/2 cycle, 50/60HZ, peak value, $T_c = 45^\circ\text{C}$	33.8/32.5	KA ² S
T_J	Junction Temperature(Diode)		-40 to +150	°C

ELECTRICAL CHARACTERISTICS (Thyristor)

T_C=25°C unless otherwise specified

Symbol	Parameter/Test Conditions		Min.	Typ.	Max.	Unit
I _{DRM}	Maximum Peak Off-State Current	V _D = V _{DRM} , T _J = 125°C			25	mA
I _{RRM}	Maximum Peak Reverse Current	V _R = V _{RRM} , T _J = 125°C			25	
V _{TM}	Maximum on-state voltage drop	I _{TM} =200A,td=10 ms, half sine			1.20	V
V _{TO}	For power-loss calculations only	T _J = 125°C			0.9	V
r _T						1.5
V _{GT}	Max. required DC gate voltage to trigger	V _A =6V, R _A =1Ω, T _J = -40°C			4.0	V
		V _A =6V, R _A =1Ω		0.8	2.5	
		V _A =6V, R _A =1Ω, T _J = 125°C			1.7	
I _{GT}	Max. required DC gate current to trigger	V _A =6V, R _A =1Ω, T _J = -40°C			270	mA
		V _A =6V, R _A =1Ω		65	150	
		V _A =6V, R _A =1Ω, T _J = 125°C			80	
V _{GD}	Max. required DC gate voltage not to trigger, V _D = V _{DRM} , T _J = 125°C				0.25	V
I _{GD}	Max. required DC gate current not to trigger, V _D = V _{DRM} , T _J = 125°C				6	mA
I _H	Maximum holding current			200	400	mA
I _L	Maximum latching current			250	500	mA
P _{GM}	Maximum peak gate power				12	W
P _{G(AV)}	Maximum average gate power				3.0	
I _{GM}	Maximum peak gate current				3.0	A
-V _{GM}	Maximum peak negative gate voltage				10	V
dv/dt	Critical Rate of Rise of Off-State Voltage, T _J =125°C,exponential to 67% rated V _{DRM}				1000	V/μs
di/dt	Max.Rate of Rise of Turned-on Current, T _J =125°C, I _{TM} =500A, rated V _{DRM}				150	A/μs

ELECTRICAL CHARACTERISTICS (Diode)

Symbol	Parameter/Test Conditions		Min.	Typ.	Max.	Unit
I _{RM}	Maximum Reverse Leakage Current	V _R = V _{RRM}			0.5	mA
		V _R = V _{RRM} , T _J = 125°C			10	
V _F	Forward Voltage Drop	I _F =200A			1.2	V
V _{TO}	For power-loss calculations only , T _J = 125°C				0.9	V
r _T						1.5

MODULE CHARACTERISTICS

T_C=25°C unless otherwise specified

T _{STG}	Storage Temperature Range				-40 to +125	°C
V _{ISO}	Isolation Breakdown Voltage	AC, 50Hz(R.M.S), t=1minute			3000	V
Torque	to heatsink	Recommended (M6)			3~5	N.m
Torque	to terminal	Recommended (M6)			3~5	N.m
R _{th(J-C)}	Junction-to-Case Thermal Resistance(Per Thyristor/Per Diode)				0.1/0.15	K/W
Weight					330	g

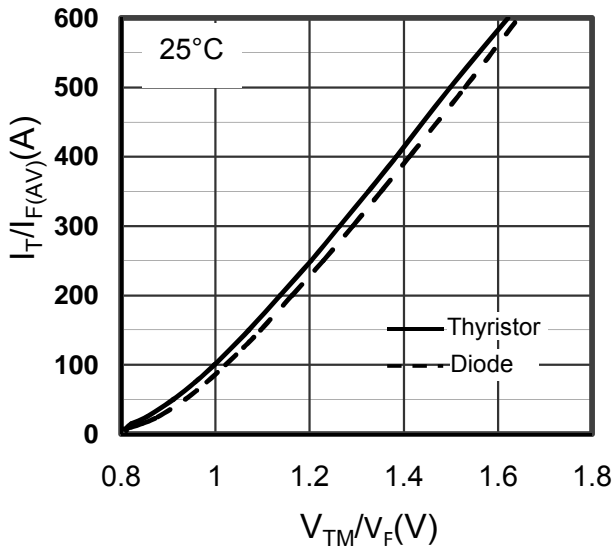

Figure1. Forward Voltage Drop vs Forward Current

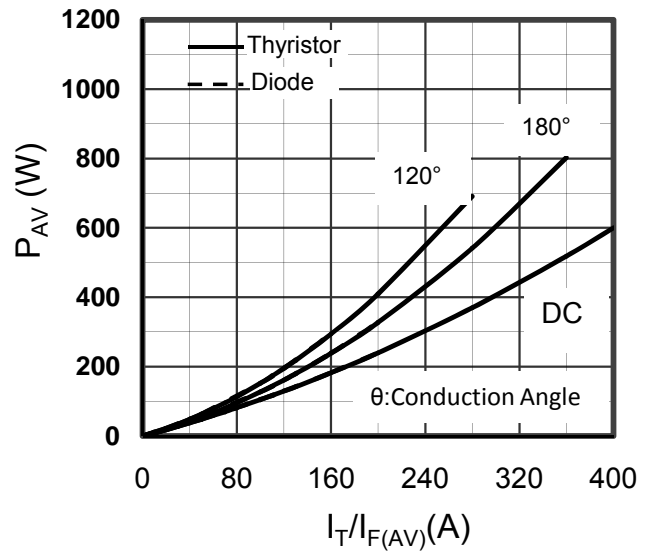

Figure2. Power dissipation vs. $I_T/I_{F(AV)}$

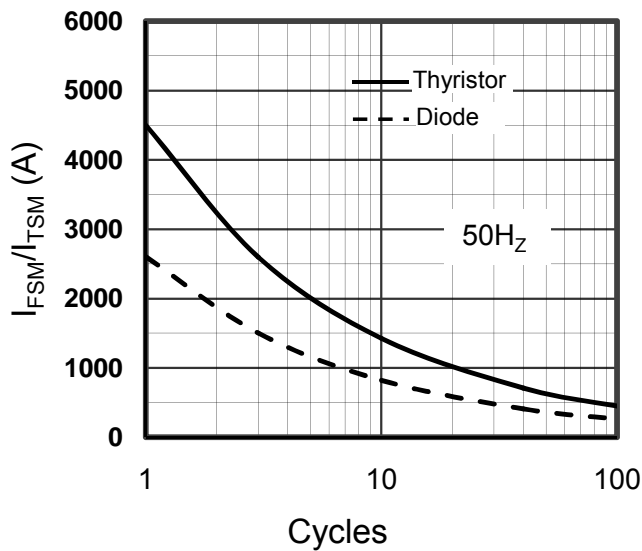

Figure3. Diode and SCR Max Non-Repetitive Surge

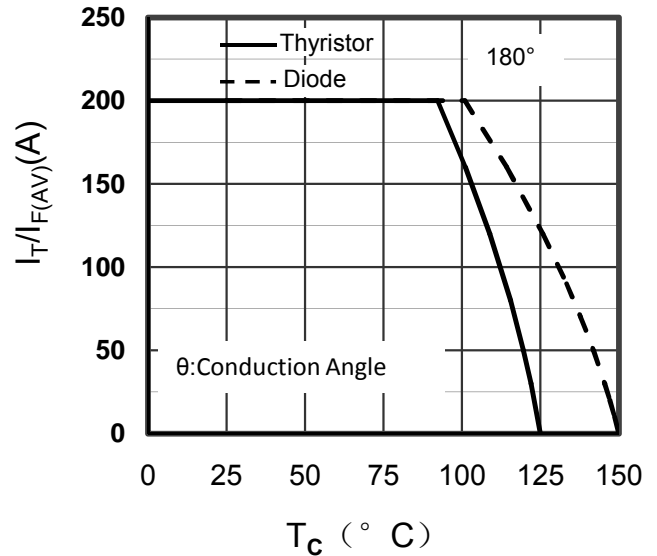

Figure4. Diode $I_{F(AV)}$ and SCR $I_{T(AV)}$ vs. T_C

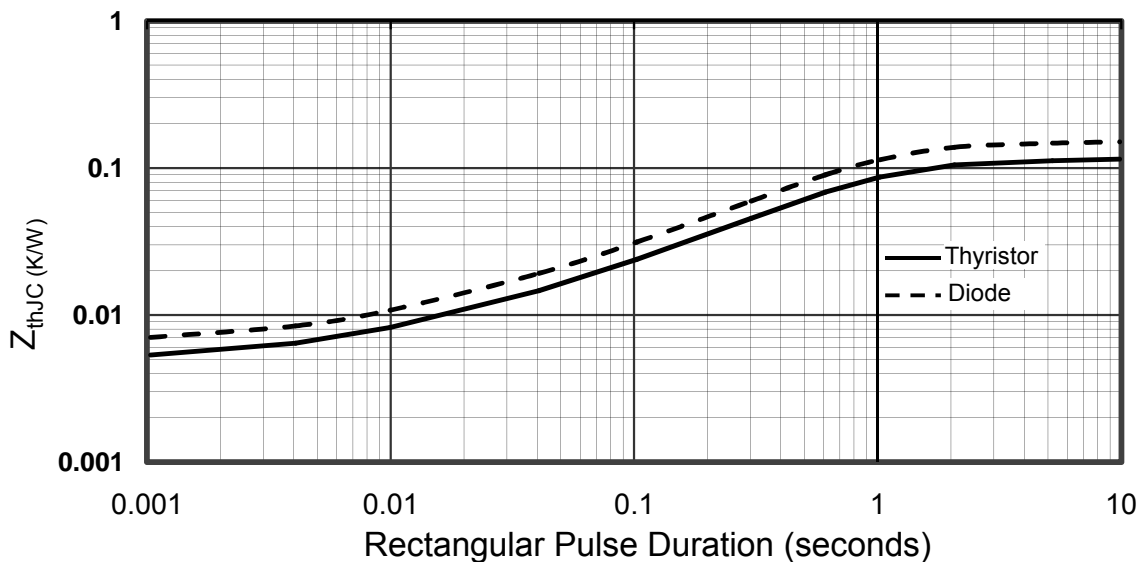

Figure5. Transient Thermal Impedance of Diode and SCR

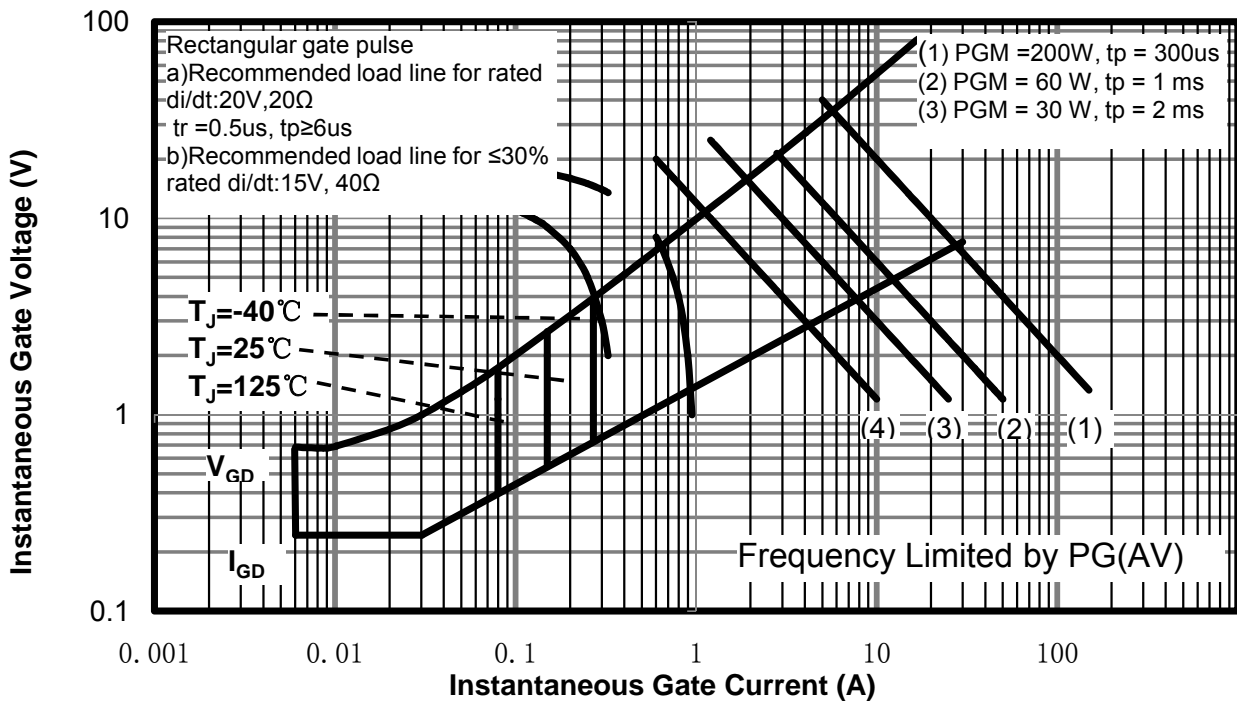
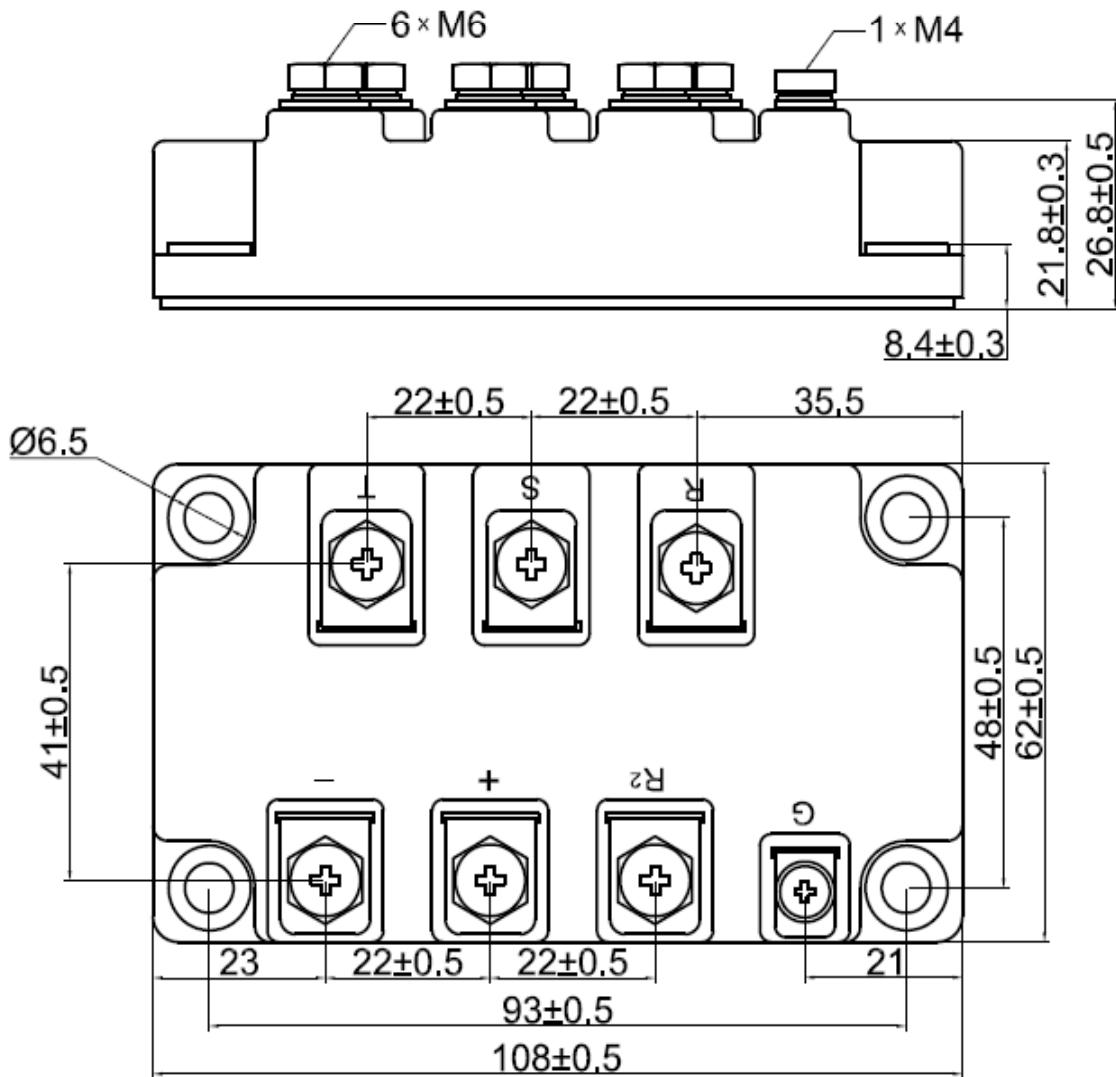

Figure 6. SCR Gate Characteristics



Dimensions in Millimeters
 Figure 7. Package Outline