

PRODUCT FEATURES

- IGBT chip in trench FS-technology
- Low switching losses
- $V_{CE(sat)}$ with positive temperature coefficient
- Fast switching and short tail current
- Free wheeling diodes with fast and soft reverse recovery

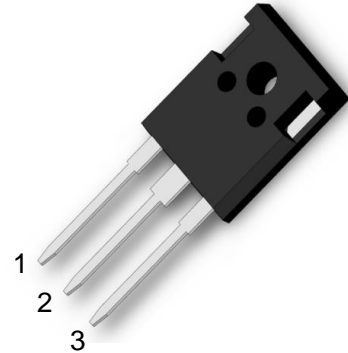

APPLICATIONS

- High frequency switching application
- Medical applications
- Motion/servo control
- UPS systems

1.Gate
2.Collector
3.Emitter

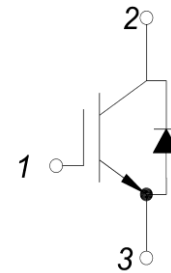

Type	V_{CES}	I_C	$V_{CE(sat)}$ $T_J=25^\circ C$	T_{Jmax}	Marking	Package
MM40GT120B	1200V	40A	1.75V	175°C	MM40GT120B	TO-247

ABSOLUTE MAXIMUM RATINGS($T_C=25^\circ C$ unless otherwise specified)

Symbol	Parameter/Test Conditions	Values	Unit	
V_{CES}	Collector Emitter Voltage	$T_J=25^\circ C$	1200	V
V_{GES}	Gate Emitter Voltage		± 20	
I_C	DC Collector Current	$T_C=25^\circ C$	65	A
		$T_C=110^\circ C$	40	
I_{Cpuls}	Pulsed collector current,tp limited by T_{Jmax}		130	
P_{tot}	Power Dissipation Per IGBT		500	W
V_{RRM}	Repetitive Reverse Voltage	$T_J=25^\circ C$	1200	V
$I_{F(AV)}$	Average Forward Current	$T_C=100^\circ C$	20	A
I_{Fpuls}	Diode pulsed current,tp limited by T_{Jmax}		40	
T_{Jmax}	Max. Junction Temperature		175	°C
T_{Jop}	Operating Temperature		-40~175	
T_{stg}	Storage Temperature		-55~150	
Torque	to heatsink	Recommended (M3)	1.1	Nm
Weight			8	g

MacMic Science & Technology Co., Ltd.

Add: #18, Hua Shan Zhong Lu, New District, Changzhou City, Jiangsu Province, P. R .of China

Tel.: +86-519-85163708 Fax: +86-519-85162291 Post Code: 213022 Website: www.macmicst.com

MM40GT120B

IGBT

ELECTRICAL CHARACTERISTICS ($T_C=25^\circ\text{C}$ unless otherwise specified)

Symbol	Parameter/Test Conditions		Min.	Typ.	Max.	Unit	
$V_{GE(th)}$	Gate Emitter Threshold Voltage	$V_{CE}=V_{GE}, I_C=1.6\text{mA}$	5.0	5.8	6.5	V	
$V_{CE(sat)}$	Collector Emitter Saturation Voltage	$I_C=40\text{A}, V_{GE}=15\text{V}, T_J=25^\circ\text{C}$		1.75	2.2		
		$I_C=40\text{A}, V_{GE}=15\text{V}, T_J=125^\circ\text{C}$		2.05			
		$I_C=40\text{A}, V_{GE}=15\text{V}, T_J=150^\circ\text{C}$		2.1			
I_{CES}	Collector Leakage Current	$V_{CE}=1200\text{V}, V_{GE}=0\text{V}, T_J=25^\circ\text{C}$			100	μA	
		$V_{CE}=1200\text{V}, V_{GE}=0\text{V}, T_J=150^\circ\text{C}$			10	mA	
I_{GES}	Gate Leakage Current	$V_{CE}=0\text{V}, V_{GE}=\pm 15\text{V}, T_J=25^\circ\text{C}$	-400		400	nA	
Q_g	Gate Charge	$V_{CE}=600\text{V}, I_C=40\text{A}, V_{GE}=15\text{V}$		0.21		μC	
C_{ies}	Input Capacitance	$V_{CE}=25\text{V}, V_{GE}=0\text{V}, f=1\text{MHz}$		5.65		nF	
C_{res}	Reverse Transfer Capacitance				53		pF
$t_{d(on)}$	Turn on Delay Time	$V_{CC}=600\text{V}, I_C=40\text{A}$ $R_G=15\Omega,$ $V_{GE}=\pm 15\text{V},$ Inductive Load	$T_J=25^\circ\text{C}$		50	ns	
			$T_J=125^\circ\text{C}$		60	ns	
			$T_J=150^\circ\text{C}$		60	ns	
t_r	Rise Time		$T_J=25^\circ\text{C}$		40	ns	
			$T_J=125^\circ\text{C}$		45	ns	
			$T_J=150^\circ\text{C}$		50	ns	
$t_{d(off)}$	Turn off Delay Time	$T_J=25^\circ\text{C}$		220	ns		
		$T_J=125^\circ\text{C}$		250	ns		
		$T_J=150^\circ\text{C}$		260	ns		
t_f	Fall Time	$T_J=25^\circ\text{C}$		80	ns		
		$T_J=125^\circ\text{C}$		150	ns		
		$T_J=150^\circ\text{C}$		170	ns		
E_{on}	Turn on Energy	$V_{CC}=600\text{V}, I_C=40\text{A}$ $R_G=15\Omega,$ $V_{GE}=\pm 15\text{V},$ Inductive Load	$T_J=125^\circ\text{C}$		3.9	mJ	
			$T_J=150^\circ\text{C}$		4.2	mJ	
E_{off}	Turn off Energy		$T_J=125^\circ\text{C}$		3.4	mJ	
			$T_J=150^\circ\text{C}$		3.6	mJ	
I_{SC}	Short Circuit Current		$t_{psc} \leq 10\mu\text{S}, V_{GE}=15\text{V}$ $T_J=125^\circ\text{C}, V_{CC}=600\text{V}$		240		A
R_{thJC}	Junction to Case Thermal Resistance (Per IGBT)				0.3	K/W	

Anti-Parallel Diode

ELECTRICAL CHARACTERISTICS ($T_C=25^\circ\text{C}$ unless otherwise specified)

Symbol	Parameter/Test Conditions		Min.	Typ.	Max.	Unit
V_F	Forward Voltage	$I_F=20\text{A}, V_{GE}=0\text{V}, T_J=25^\circ\text{C}$		1.9	2.4	V
		$I_F=20\text{A}, V_{GE}=0\text{V}, T_J=125^\circ\text{C}$		1.65		
		$I_F=20\text{A}, V_{GE}=0\text{V}, T_J=150^\circ\text{C}$		1.6		
t_{rr}	Reverse Recovery Time	$I_F=20\text{A}, V_R=600\text{V}$ $di_F/dt=-700\text{A}/\mu\text{s}$ $T_J=150^\circ\text{C}$		210		ns
I_{RRM}	Max. Reverse Recovery Current			29		A
Q_{RR}	Reverse Recovery Charge			3.6		μC
E_{rec}	Reverse Recovery Energy			1.4		mJ
R_{thJCD}	Junction to Case Thermal Resistance (Per Diode)				1.0	K/W

MM40GT120B

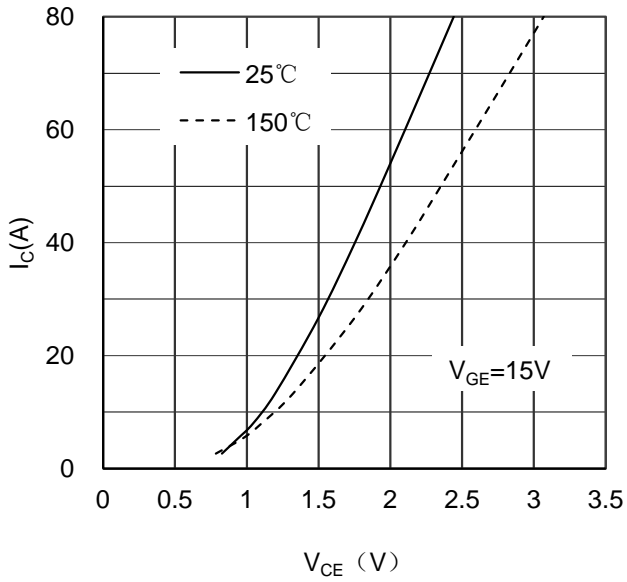

Figure 1. Typical Output Characteristics IGBT

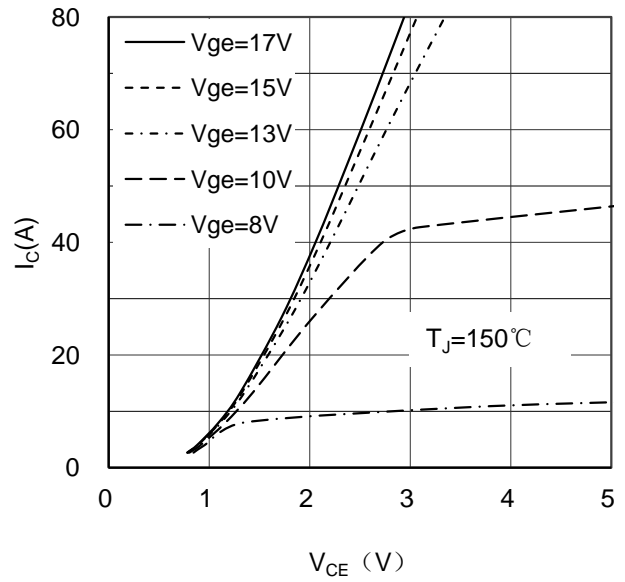

Figure 2. Typical Output Characteristics IGBT

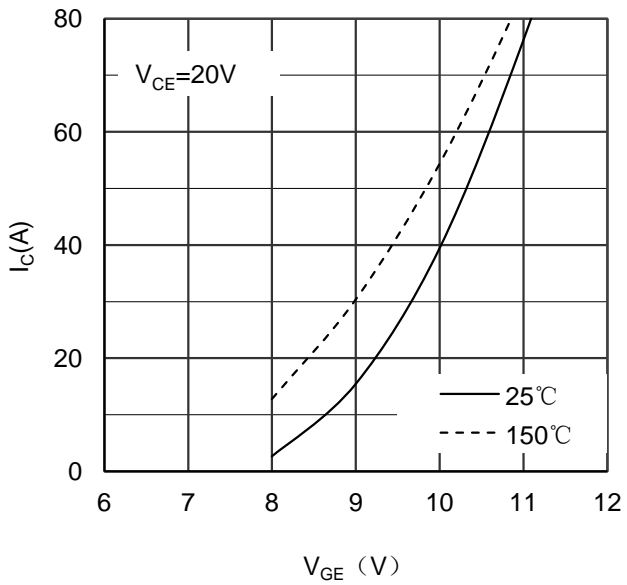

Figure 3. Typical Transfer characteristics IGBT

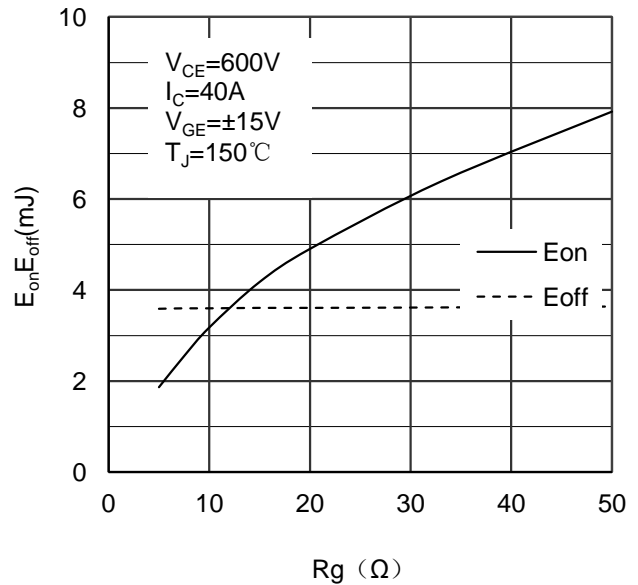

Figure 4. Switching Energy vs Gate Resistor IGBT

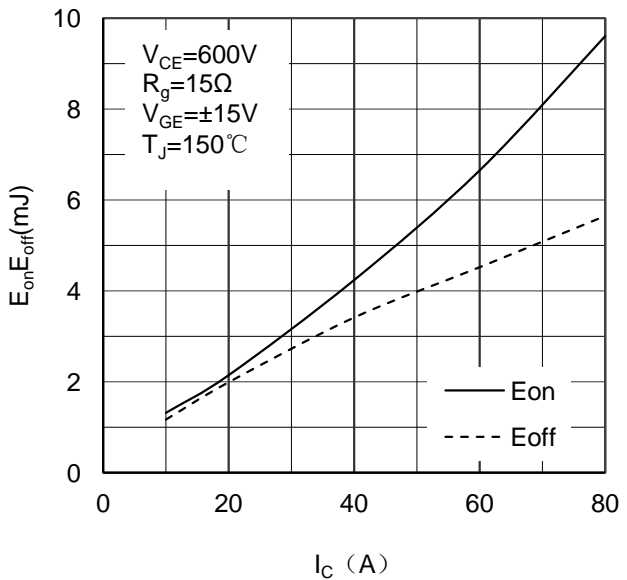

Figure 5. Switching Energy vs Collector Current IGBT

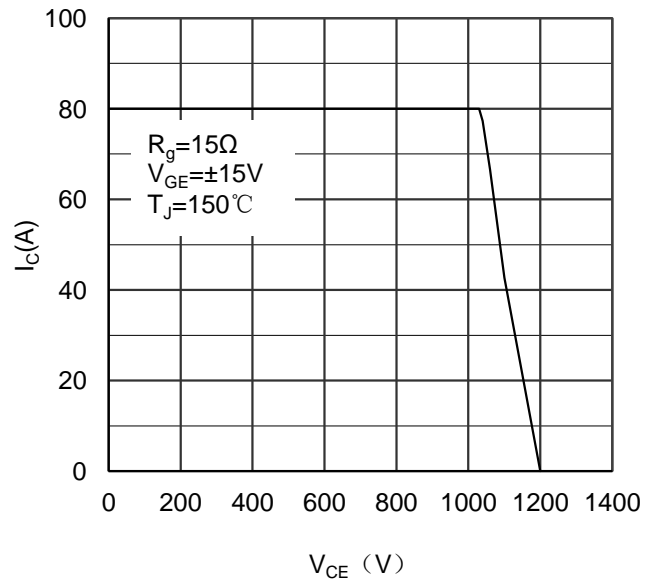

Figure 6. Reverse Biased Safe Operating Area IGBT

MM40GT120B

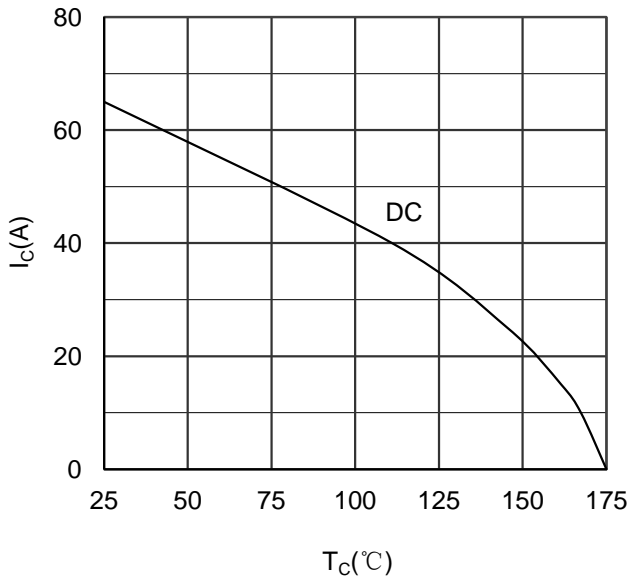

Figure 7. Collector Current vs Case temperature IGBT

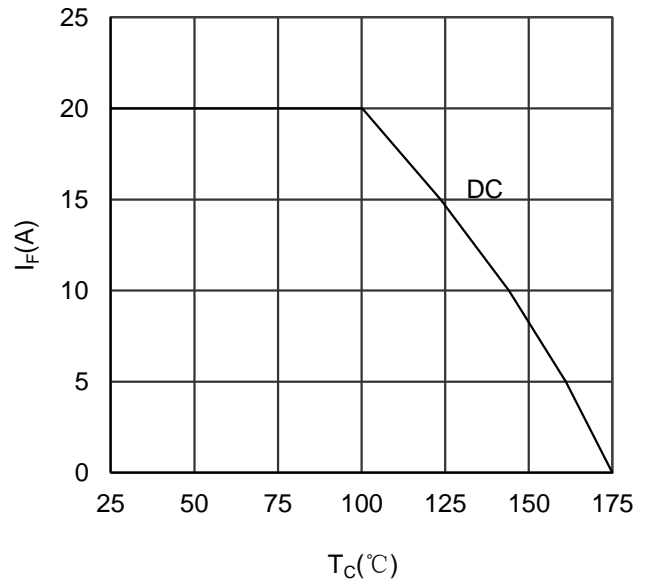

Figure 8. Forward current vs Case temperature Diode

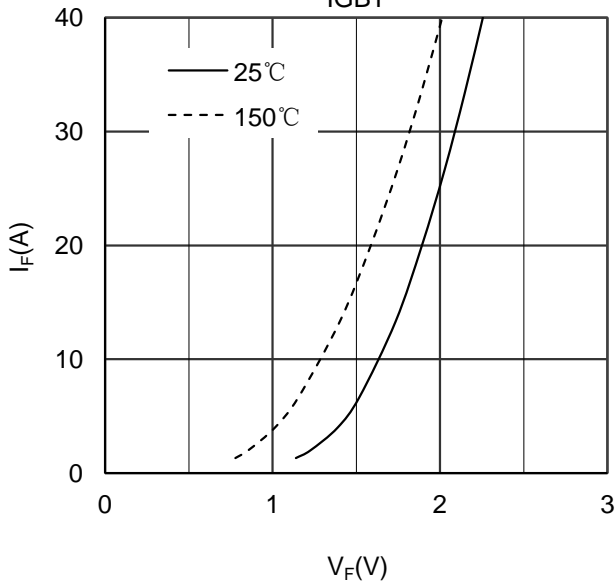

Figure 9. Diode Forward Characteristics Diode

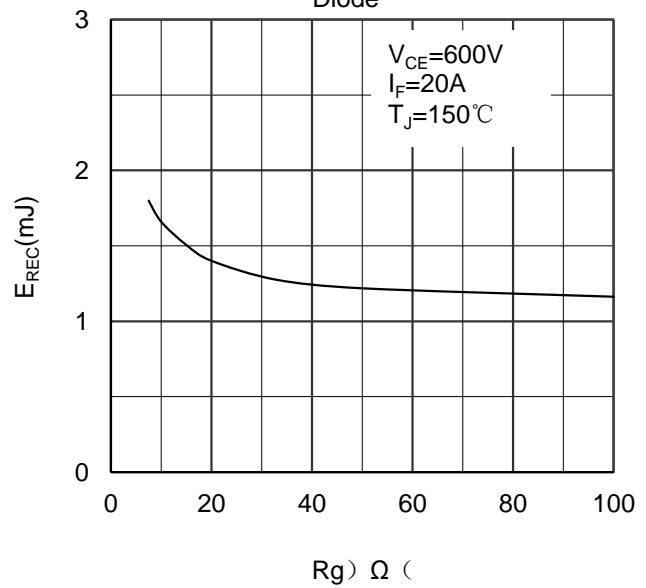

Figure 10. Switching Energy vs Gate Resistor Diode

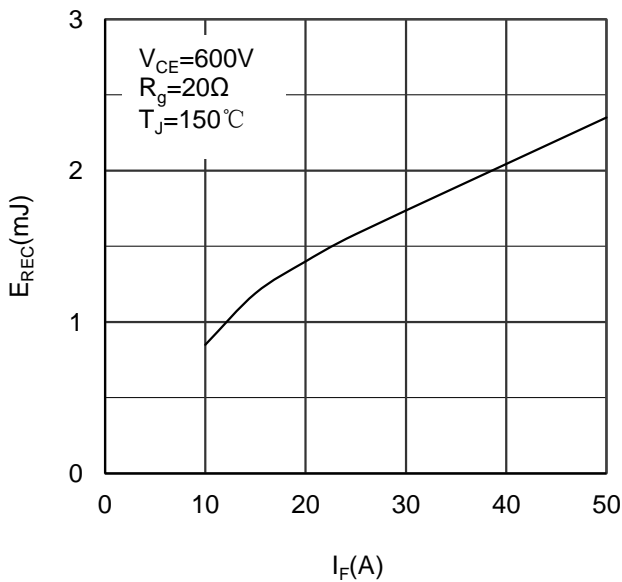

Figure 11. Switching Energy vs Forward Current Diode

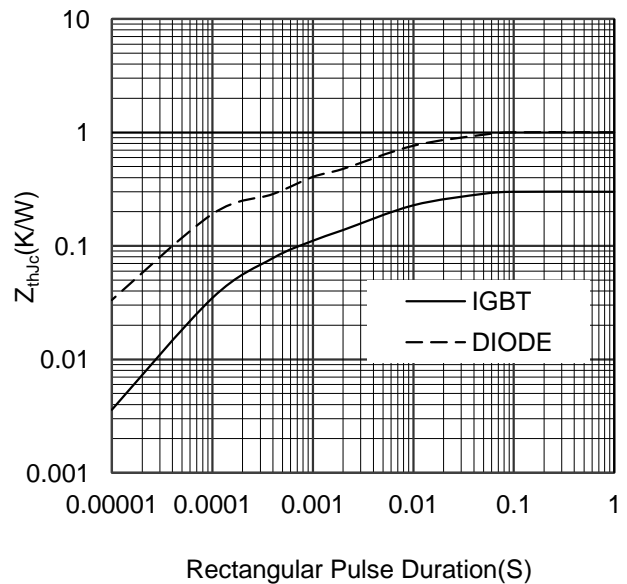
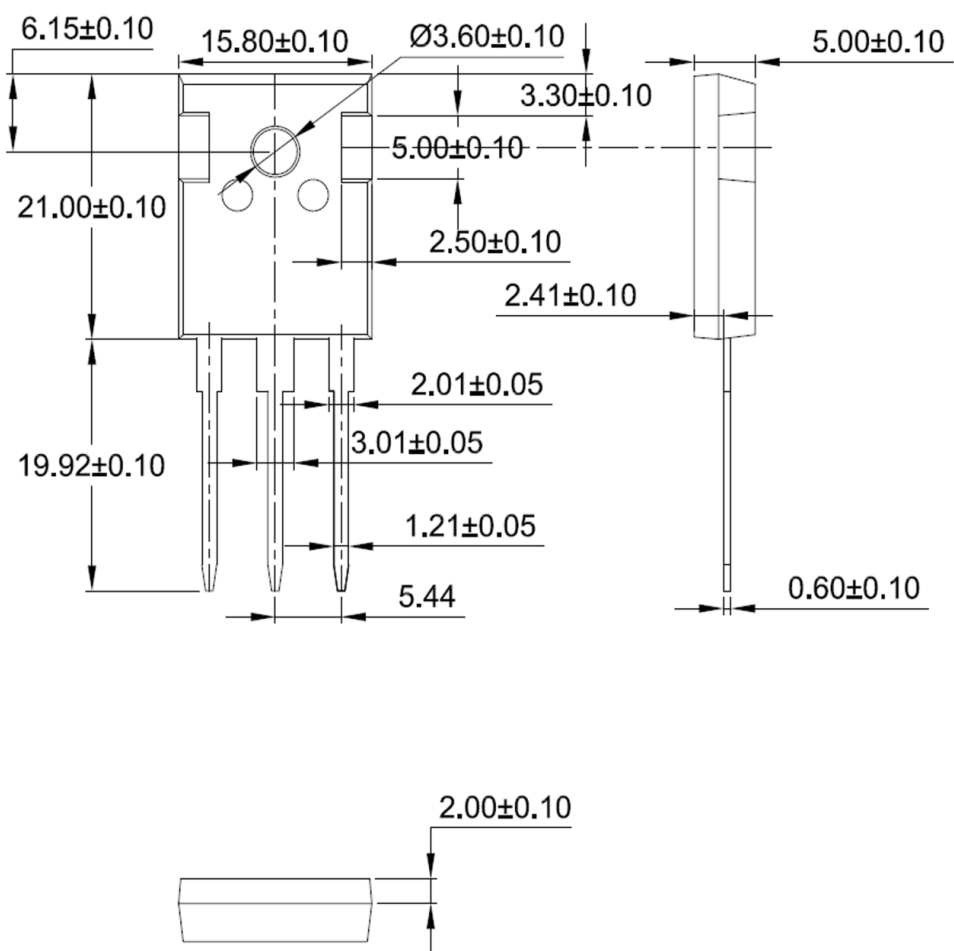

Figure 12. Transient Thermal Impedance of Diode and IGBT

MM40GT120B



Dimensions in (mm)
Figure 13. Package Outline