

## PRODUCT FEATURES

- Low Forward Voltage
- High Surge Current Capability
- Low Leakage Current
- Low Inductance Package

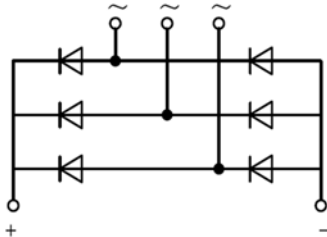

## APPLICATIONS

- Field Supply For DC Motors
- Line Rectifiers For Transistorized AC Motor Controllers
- Non-controllable Rectifiers For AC/DC Converter
- UL:E332185



## Module Type

Module Type	$V_{RRM}$ Repetitive Peak Reverse Voltage	$V_{RSM}$ Non-Repetitive Peak Reverse Voltage	Unit
MMD70E180X	1800	1900	V

## ABSOLUTE MAXIMUM RATINGS( $T_C=25^{\circ}C$ unless otherwise specified)

Symbol	Parameter/Test Conditions		Values	Unit	
$I_D$	Output Current(D.C.)	Three phase, full wave, $T_C=95^{\circ}C$	70	A	
$I_{FSM}$	Non-Repetitive Surge Forward Current	1/2 cycle, 50HZ, peak value, $T_J=45^{\circ}C$	700		
		1/2 cycle, 60HZ, peak value, $T_J=45^{\circ}C$	750		
$I^2t$	For Fusing	1/2 cycle, 50HZ, peak value, $T_J=45^{\circ}C$	2.45	KA <sup>2</sup> S	
		1/2 cycle, 60HZ, peak value, $T_J=45^{\circ}C$	2.33		
$P_D$	Power Dissipation		690	W	
$T_J$	Junction Temperature		-40 to +150	$^{\circ}C$	
$T_{STG}$	Storage Temperature Range		-40 to +125	$^{\circ}C$	
$V_{ISO}$	Isolation Breakdown Voltage	AC, 50Hz(R.M.S), $t=1$ minute	3000	V	
Torque	Module to Sink	Recommended (M5)	2.5~5	Nm	
Torque	Module Electrodes	Recommended (M5)	2.5~5	Nm	
$R_{thJC}$	Junction to Case Thermal Resistance		per diode	1.1	K/W
			per module	0.18	
Weight			150	g	

MacMic Science & Technology Co., Ltd.

Add: #18, Hua Shan Zhong Lu, New District, Changzhou City, Jiangsu Province, P. R. of China

Tel.: +86-519-85163708 Fax: +86-519-85162291 Post Code: 213022 Website: www.macmicst.com

# MMD70E180X

## ELECTRICAL CHARACTERISTICS ( $T_C=25^\circ\text{C}$ unless otherwise specified)

Symbol	Parameter/Test Conditions	Min.	Typ.	Max.	Unit
$I_{RM}$	Maximum Reverse Leakage Current			0.5	mA
				$V_R = V_{RRM}, T_J = 125^\circ\text{C}$	
$V_F$	Forward Voltage Drop			1.35	V
$V_{TO}$	For power loss calculations only, $T_J = 125^\circ\text{C}$			0.95	V
$r_T$				4.7	m $\Omega$

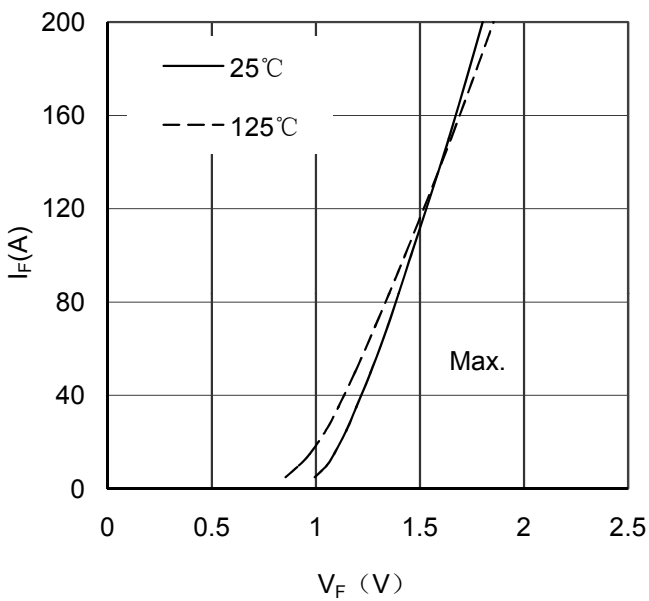

Figure 1. Forward Voltage Drop vs Forward Current

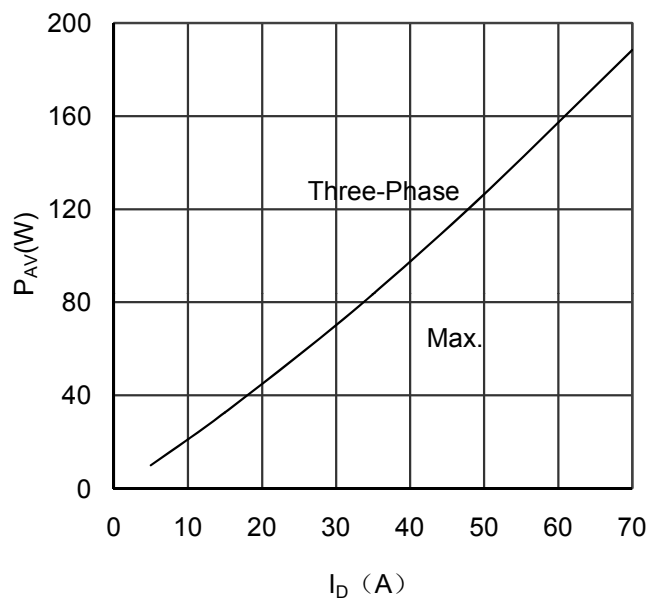

Figure 2. Power dissipation vs Output Current

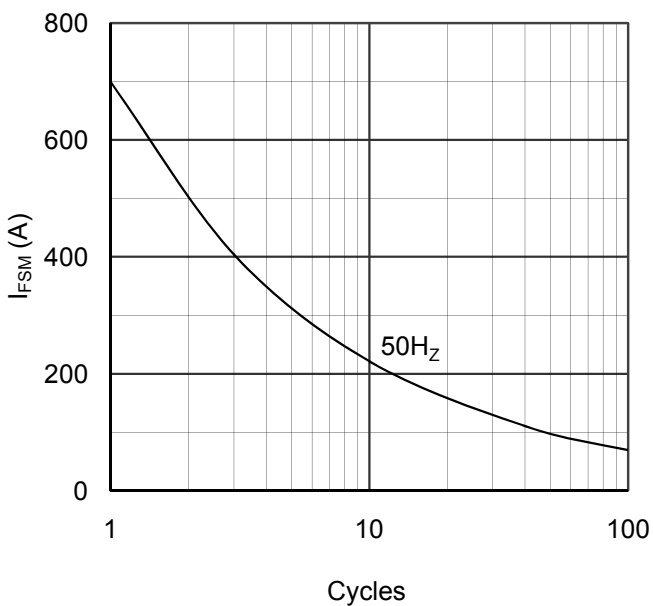

Figure 3. Max Non-Repetitive Forward Surge Current

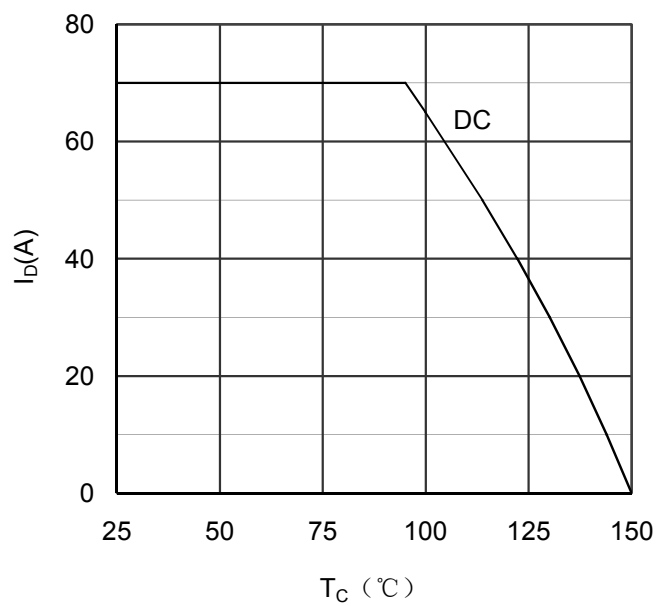
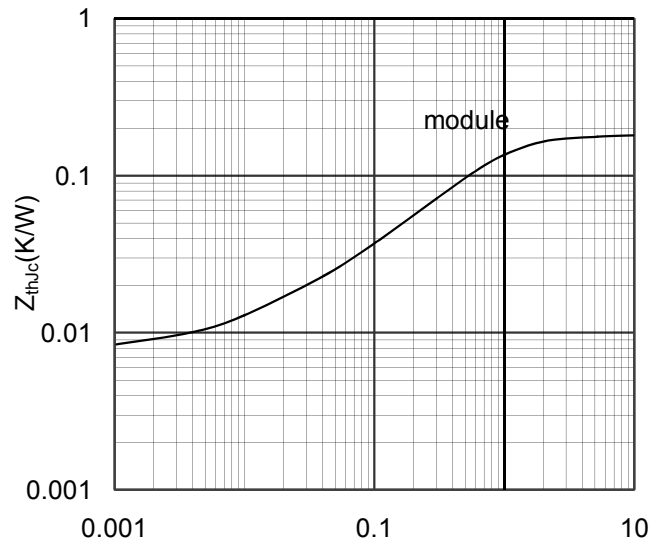
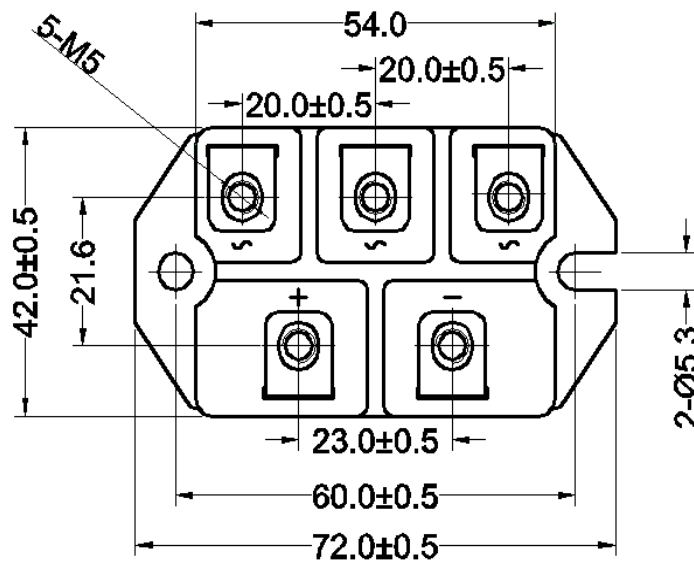
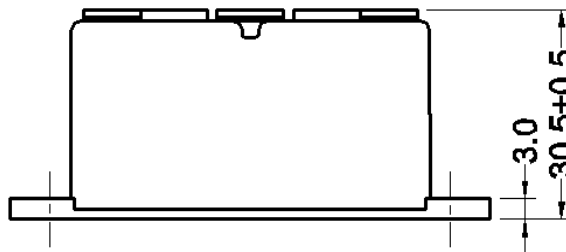

Figure 4. Output current vs Case temperature



Rectangular Pulse Duration(S)  
Figure 5. Transient Thermal Impedance



Dimensions in (mm)  
Figure 6. Package Outline