

PRODUCT FEATURES

- Low Forward Voltage
- High Surge Current Capability
- Low Leakage Current
- Low Inductance Package

APPLICATIONS

- Field Supply For DC Motors
- Line Rectifiers For Transistorized AC Motor Controllers
- Non-controllable Rectifiers For AC/DC Converter
- UL:E332185

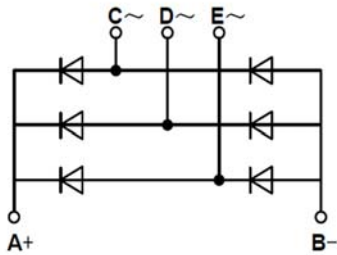

Module Type

| Module Type | V_{RRM} Repetitive Peak Reverse Voltage | V_{RSM} Non-Repetitive Peak Reverse Voltage | Unit |
|-------------|--|--|------|
| | | | V |
| MMD200F200X | 2000 | 2100 | |

ABSOLUTE MAXIMUM RATINGS($T_C=25^{\circ}C$ unless otherwise specified)

| Symbol | Parameter/Test Conditions | | Values | Unit | |
|------------|--------------------------------------|--|-------------|-------------------|-----|
| I_D | Output Current(D.C.) | Three phase, full wave, $T_c=95^{\circ}C$ | 200 | A | |
| I_{FSM} | Non-Repetitive Surge Forward Current | 1/2 cycle, 50HZ, peak value, $T_J=45^{\circ}C$ | 2000 | | |
| | | 1/2 cycle, 60HZ, peak value, $T_J=45^{\circ}C$ | 2200 | | |
| I^2t | For Fusing | 1/2 cycle, 50HZ, peak value, $T_J=45^{\circ}C$ | 20.0 | KA ² S | |
| | | 1/2 cycle, 60HZ, peak value, $T_J=45^{\circ}C$ | 20.1 | | |
| P_D | Power Dissipation | | 1389 | W | |
| T_J | Junction Temperature | | -40 to +150 | $^{\circ}C$ | |
| T_{STG} | Storage Temperature Range | | -40 to +125 | $^{\circ}C$ | |
| V_{ISO} | Isolation Breakdown Voltage | AC, 50Hz(R.M.S), t=1minute | 3000 | V | |
| Torque | Module to Sink | Recommended (M6) | 3~5 | Nm | |
| Torque | Module Electrodes | Recommended (M6) | 3~5 | Nm | |
| R_{thJC} | Junction to Case Thermal Resistance | | per diode | 0.54 | K/W |
| | | | per module | 0.09 | |
| Weight | | | 250 | g | |

MacMic Science & Technology Co., Ltd.

Add: #18, Hua Shan Zhong Lu, New District, Changzhou City, Jiangsu Province, P. R. of China

Tel.: +86-519-85163708 Fax: +86-519-85162291 Post Code: 213022 Website: www.macmicst.com

MMD200F200X

ELECTRICAL CHARACTERISTICS ($T_C=25^\circ\text{C}$ unless otherwise specified)

| Symbol | Parameter/Test Conditions | Min. | Typ. | Max. | Unit |
|----------|---|------|------|--|------------|
| I_{RM} | Maximum Reverse Leakage Current | | | 0.5 | mA |
| | | | | $V_R = V_{RRM}, T_J = 125^\circ\text{C}$ | |
| V_F | Forward Voltage Drop | | | 1.45 | V |
| V_{TO} | For power loss calculations only, $T_J = 125^\circ\text{C}$ | | | 0.85 | V |
| r_T | | | | 3 | m Ω |

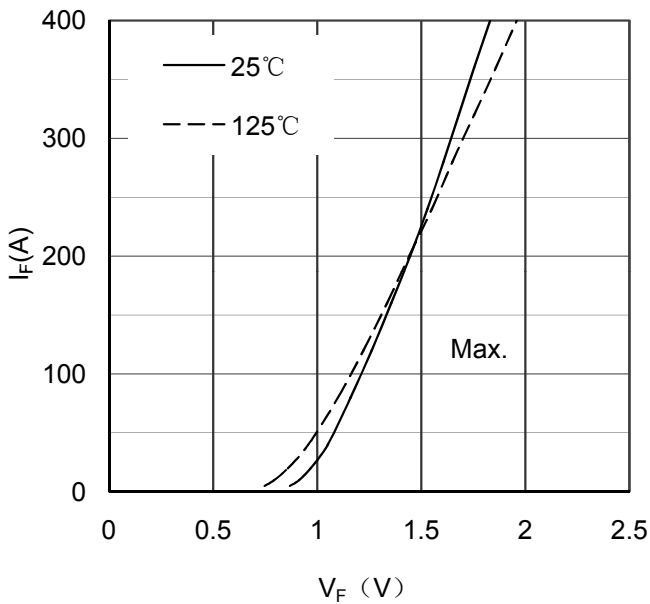

Figure 1. Forward Voltage Drop vs Forward Current

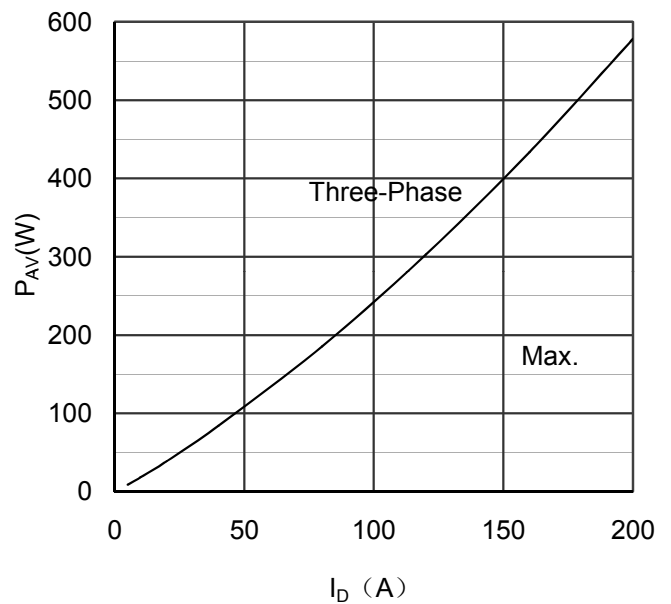

Figure 2. Power dissipation vs Output Current

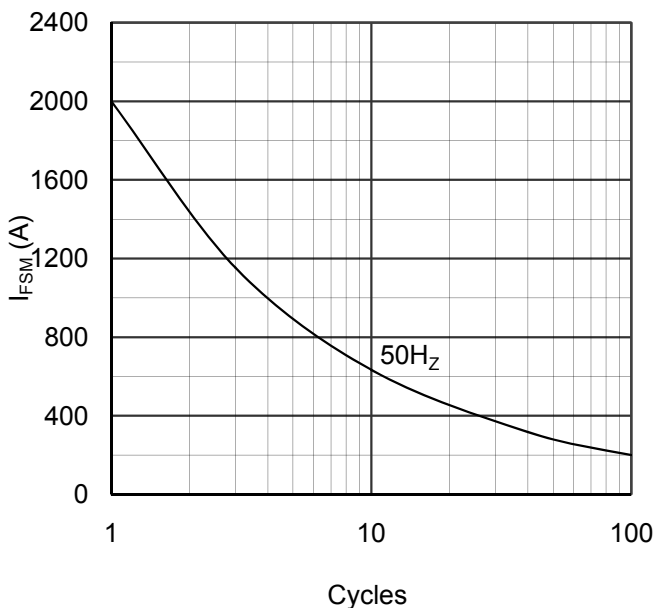

Figure 3. Max Non-Repetitive Forward Surge Current

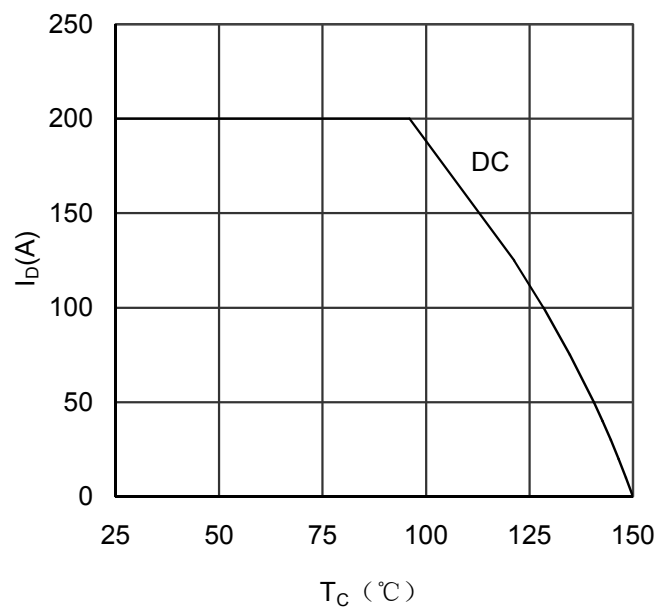
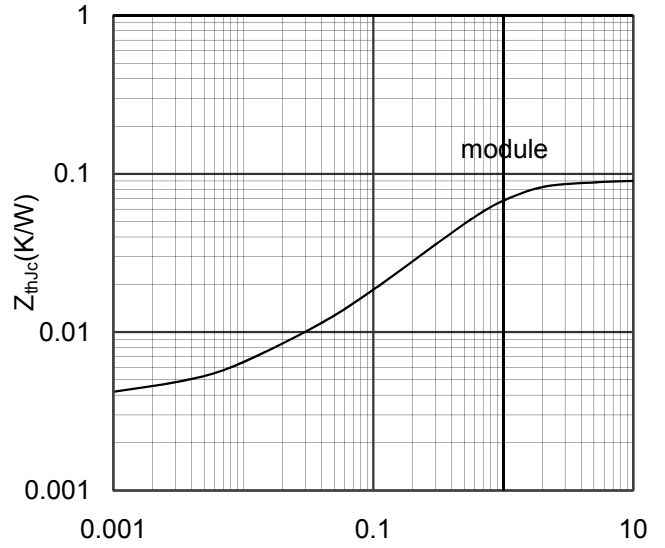
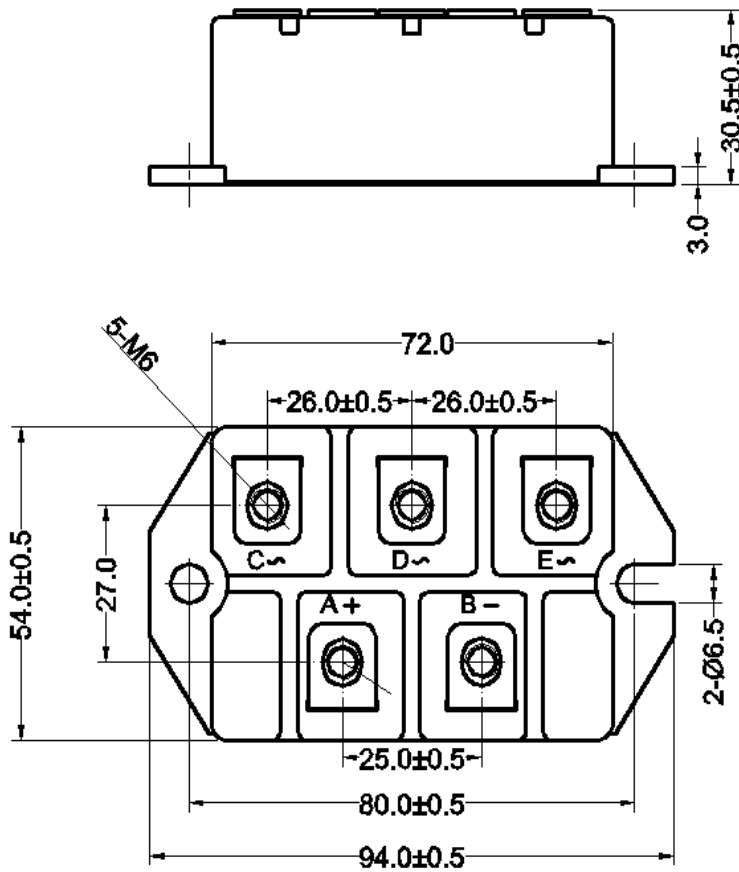

Figure 4. Output current vs Case temperature



Rectangular Pulse Duration(S)
Figure 5. Transient Thermal Impedance



Dimensions in (mm)
Figure 6. Package Outline