

PRODUCT FEATURES

- IGBT CHIP(Trench+Field Stop technology)
- Substrate for Low Thermal Resistance
- Low saturation voltage and positive temperature coefficient
- Fast switching and short tail current
- Free wheeling diodes with fast and soft reverse recovery
- Solder Contact Technology, Rugged mounting due to integrated Mounting clamps
- Temperature sense included

APPLICATIONS

- AC motor control
- Motion/servo control
- Inverter and power supplies

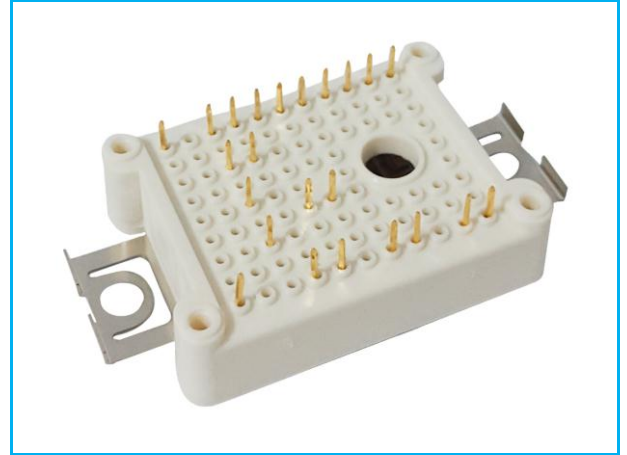

Rectifier+Brake+Inverter

IGBT-inverter

ABSOLUTE MAXIMUM RATINGS($T_C=25^{\circ}\text{C}$ unless otherwise specified)

Symbol	Parameter/Test Conditions	Values	Unit
V_{CES}	Collector Emitter Voltage $T_J=25^{\circ}\text{C}$	1200	V
V_{GES}	Gate Emitter Voltage	± 20	
I_C	DC Collector Current	$T_C=25^{\circ}\text{C}, T_{Jmax}=175^{\circ}\text{C}$	19
		$T_C=105^{\circ}\text{C}, T_{Jmax}=175^{\circ}\text{C}$	10
I_{CM}	Repetitive Peak Collector Current $tp=1\text{ms}$	20	A
P_{tot}	Power Dissipation Per IGBT $T_C=25^{\circ}\text{C}, T_{Jmax}=175^{\circ}\text{C}$	107	

Diode-inverter

ABSOLUTE MAXIMUM RATINGS ($T_C=25^{\circ}\text{C}$ unless otherwise specified)

Symbol	Parameter/Test Conditions	Values	Unit
V_{RRM}	Repetitive Reverse Voltage $T_J=25^{\circ}\text{C}$	1200	V
$I_{F(AV)}$	Average Forward Current	10	A
I_{FRM}	Repetitive Peak Forward Current $tp=1\text{ms}$	20	
I^2t		$T_J=125^{\circ}\text{C}, t=10\text{ms}, V_R=0\text{V}$	A^2s

MacMic Science & Technology Co., Ltd.

Add: #18, Hua Shan Zhong Lu, New District, Changzhou City, Jiangsu Province, P. R .of China

Tel.: +86-519-85163708 Fax: +86-519-85162291 Post Code: 213022 Website: www.macmicst.com

MMG10CB120XB6TC

IGBT-inverter

ELECTRICAL CHARACTERISTICS ($T_C=25^\circ\text{C}$ unless otherwise specified)

Symbol	Parameter/Test Conditions		Min.	Typ.	Max.	Unit	
$V_{GE(th)}$	Gate Emitter Threshold Voltage	$V_{CE}=V_{GE}, I_C=0.25\text{mA}$	5.0	5.8	6.5	V	
$V_{CE(sat)}$	Collector Emitter Saturation Voltage	$I_C=10\text{A}, V_{GE}=15\text{V}, T_J=25^\circ\text{C}$		1.85	2.25		
		$I_C=10\text{A}, V_{GE}=15\text{V}, T_J=125^\circ\text{C}$		2.15			
		$I_C=10\text{A}, V_{GE}=15\text{V}, T_J=150^\circ\text{C}$		2.25			
I_{CES}	Collector Leakage Current	$V_{CE}=1200\text{V}, V_{GE}=0\text{V}, T_J=25^\circ\text{C}$			100	μA	
		$V_{CE}=1200\text{V}, V_{GE}=0\text{V}, T_J=150^\circ\text{C}$			10	mA	
I_{GES}	Gate Leakage Current	$V_{CE}=0\text{V}, V_{GE}=\pm 20\text{V}, T_J=25^\circ\text{C}$	-400		400	nA	
R_{gint}	Integrated Gate Resistor			0		Ω	
Q_g	Gate Charge	$V_{CE}=600\text{V}, I_C=10\text{A}, V_{GE}=15\text{V}$		0.08		μC	
C_{ies}	Input Capacitance	$V_{CE}=25\text{V}, V_{GE}=0\text{V}, f=1\text{MHz}$		0.8		nF	
C_{res}	Reverse Transfer Capacitance				35		pF
$t_{d(on)}$	Turn on Delay Time	$V_{CC}=600\text{V}, I_C=10\text{A}$ $R_G=50\Omega,$ $V_{GE}=\pm 15\text{V},$ Inductive Load	$T_J=25^\circ\text{C}$		20	ns	
			$T_J=125^\circ\text{C}$		25	ns	
			$T_J=150^\circ\text{C}$		25	ns	
t_r	Rise Time		$T_J=25^\circ\text{C}$		22	ns	
			$T_J=125^\circ\text{C}$		24	ns	
			$T_J=150^\circ\text{C}$		24	ns	
$t_{d(off)}$	Turn off Delay Time	$T_J=25^\circ\text{C}$		150	ns		
		$T_J=125^\circ\text{C}$		180	ns		
		$T_J=150^\circ\text{C}$		210	ns		
t_f	Fall Time	$T_J=25^\circ\text{C}$		180	ns		
		$T_J=125^\circ\text{C}$		215	ns		
		$T_J=150^\circ\text{C}$		225	ns		
E_{on}	Turn on Energy	$V_{CC}=600\text{V}, I_C=10\text{A}$ $R_G=50\Omega,$ $V_{GE}=\pm 15\text{V},$ Inductive Load	$T_J=125^\circ\text{C}$		1.15	mJ	
			$T_J=150^\circ\text{C}$		1.25	mJ	
E_{off}	Turn off Energy		$T_J=125^\circ\text{C}$		0.69	mJ	
			$T_J=150^\circ\text{C}$		0.72	mJ	
I_{SC}	Short Circuit Current		$t_{psc} \leq 10\mu\text{s}, V_{GE}=15\text{V}$ $T_J=150^\circ\text{C}, V_{CC}=800\text{V}$		40		A
R_{thJC}	Junction to Case Thermal Resistance (Per IGBT)			1.25	1.4	K/W	

Diode-inverter

ELECTRICAL CHARACTERISTICS ($T_C=25^\circ\text{C}$ unless otherwise specified)

Symbol	Parameter/Test Conditions		Min.	Typ.	Max.	Unit
V_F	Forward Voltage	$I_F=10\text{A}, V_{GE}=0\text{V}, T_J=25^\circ\text{C}$		1.95	2.45	V
		$I_F=10\text{A}, V_{GE}=0\text{V}, T_J=125^\circ\text{C}$		1.55		
		$I_F=10\text{A}, V_{GE}=0\text{V}, T_J=150^\circ\text{C}$		1.5		
t_{rr}	Reverse Recovery Time	$I_F=10\text{A}, V_R=600\text{V}$ $di_F/dt=500\text{A}/\mu\text{s}$ $T_J=150^\circ\text{C}$		161		ns
I_{RRM}	Max. Reverse Recovery Current			15		A
Q_{RR}	Reverse Recovery Charge			1.6		μC
E_{rec}	Reverse Recovery Energy			0.57		mJ
R_{thJCD}	Junction to Case Thermal Resistance (Per Diode)			1.75	1.9	K/W

MMG10CB120XB6TC

Diode-RECTIFIER

ABSOLUTE MAXIMUM RATINGS ($T_C=25^\circ\text{C}$ unless otherwise specified)

Symbol	Parameter/Test Conditions		Values	Unit
V_{RRM}	Repetitive Reverse Voltage	$T_J=25^\circ\text{C}$	1600	V
I_{FRMS}	R.M.S. Forward Current Per Diode	$T_C=80^\circ\text{C}$	25	A
I_{RMS}	R.M.S. Current at rectifier output		30	
I_{FSM}	Non Repetitive Surge Forward Current	$T_J=45^\circ\text{C}$, $t=10\text{ms}$, 50Hz	250	
		$T_J=45^\circ\text{C}$, $t=8.3\text{ms}$, 60Hz	275	
I^2t		$T_J=45^\circ\text{C}$, $t=10\text{ms}$, 50Hz	312	A^2S
		$T_J=45^\circ\text{C}$, $t=8.3\text{ms}$, 60Hz	313	

Diode-RECTIFIER

ELECTRICAL CHARACTERISTICS ($T_C=25^\circ\text{C}$ unless otherwise specified)

Symbol	Parameter/Test Conditions		Min.	Typ.	Max.	Unit
V_F	Forward Voltage	$I_F=10\text{A}$, $T_J=25^\circ\text{C}$		1.01		V
		$I_F=10\text{A}$, $T_J=150^\circ\text{C}$		0.95		V
I_R	Reverse Leakage Current	$V_R=1600\text{V}$, $T_J=25^\circ\text{C}$		50	500	μA
		$V_R=1600\text{V}$, $T_J=150^\circ\text{C}$		1	10	mA
R_{thJCD}	Junction to Case Thermal Resistance (Per Diode)				1.35	K/W

IGBT-Brake chopper

ABSOLUTE MAXIMUM RATINGS ($T_C=25^\circ\text{C}$ unless otherwise specified)

Symbol	Parameter/Test Conditions		Values	Unit
V_{CES}	Collector Emitter Voltage	$T_J=25^\circ\text{C}$	1200	V
V_{GES}	Gate Emitter Voltage		± 20	
I_C	DC Collector Current	$T_C=25^\circ\text{C}$, $T_{Jmax}=175^\circ\text{C}$	19	A
		$T_C=105^\circ\text{C}$, $T_{Jmax}=175^\circ\text{C}$	10	
I_{CM}	Repetitive Peak Collector Current	$t_p=1\text{ms}$	20	
P_{tot}	Power Dissipation Per IGBT	$T_C=25^\circ\text{C}$, $T_{Jmax}=175^\circ\text{C}$	107	W

Diode-Brake chopper

ABSOLUTE MAXIMUM RATINGS ($T_C=25^\circ\text{C}$ unless otherwise specified)

Symbol	Parameter/Test Conditions		Values	Unit
V_{RRM}	Repetitive Reverse Voltage	$T_J=25^\circ\text{C}$	1200	V
$I_{F(AV)}$	Average Forward Current		10	A
I_{FRM}	Repetitive Peak Forward Current	$t_p=1\text{ms}$	20	
I^2t		$T_J=125^\circ\text{C}$, $t=10\text{ms}$, $V_R=0\text{V}$	18	A^2S

MMG10CB120XB6TC

IGBT-Brake chopper

ELECTRICAL CHARACTERISTICS ($T_C=25^\circ\text{C}$ unless otherwise specified)

Symbol	Parameter/Test Conditions		Min.	Typ.	Max.	Unit	
$V_{GE(th)}$	Gate Emitter Threshold Voltage	$V_{CE}=V_{GE}, I_C=0.25\text{mA}$	5.0	5.8	6.5	V	
$V_{CE(sat)}$	Collector Emitter Saturation Voltage	$I_C=10\text{A}, V_{GE}=15\text{V}, T_J=25^\circ\text{C}$		1.85	2.25		
		$I_C=10\text{A}, V_{GE}=15\text{V}, T_J=125^\circ\text{C}$		2.15			
		$I_C=10\text{A}, V_{GE}=15\text{V}, T_J=150^\circ\text{C}$		2.25			
I_{CES}	Collector Leakage Current	$V_{CE}=1200\text{V}, V_{GE}=0\text{V}, T_J=25^\circ\text{C}$			100	μA	
		$V_{CE}=1200\text{V}, V_{GE}=0\text{V}, T_J=150^\circ\text{C}$			10	mA	
I_{GES}	Gate Leakage Current	$V_{CE}=0\text{V}, V_{GE}=\pm 20\text{V}, T_J=25^\circ\text{C}$	-400		400	nA	
R_{gint}	Integrated Gate Resistor			0		Ω	
Q_g	Gate Charge	$V_{CE}=600\text{V}, I_C=10\text{A}, V_{GE}=15\text{V}$		0.08		μC	
C_{ies}	Input Capacitance	$V_{CE}=25\text{V}, V_{GE}=0\text{V}, f=1\text{MHz}$		0.8		nF	
C_{res}	Reverse Transfer Capacitance				35		pF
$t_{d(on)}$	Turn on Delay Time	$V_{CC}=600\text{V}, I_C=10\text{A}$ $R_G=50\Omega,$ $V_{GE}=\pm 15\text{V},$ Inductive Load	$T_J=25^\circ\text{C}$		20	ns	
			$T_J=125^\circ\text{C}$		25	ns	
			$T_J=150^\circ\text{C}$		25	ns	
t_r	Rise Time		$T_J=25^\circ\text{C}$		22	ns	
			$T_J=125^\circ\text{C}$		24	ns	
			$T_J=150^\circ\text{C}$		24	ns	
$t_{d(off)}$	Turn off Delay Time	$T_J=25^\circ\text{C}$		150	ns		
		$T_J=125^\circ\text{C}$		180	ns		
		$T_J=150^\circ\text{C}$		210	ns		
t_f	Fall Time	$T_J=25^\circ\text{C}$		180	ns		
		$T_J=125^\circ\text{C}$		215	ns		
		$T_J=150^\circ\text{C}$		225	ns		
E_{on}	Turn on Energy	$V_{CC}=600\text{V}, I_C=10\text{A}$ $R_G=50\Omega,$ $V_{GE}=\pm 15\text{V},$ Inductive Load	$T_J=125^\circ\text{C}$		1.15	mJ	
			$T_J=150^\circ\text{C}$		1.25	mJ	
E_{off}	Turn off Energy		$T_J=125^\circ\text{C}$		0.69	mJ	
			$T_J=150^\circ\text{C}$		0.72	mJ	
I_{SC}	Short Circuit Current		$t_{psc} \leq 10\mu\text{s}, V_{GE}=15\text{V}$ $T_J=150^\circ\text{C}, V_{CC}=800\text{V}$		40		A
R_{thJC}	Junction to Case Thermal Resistance (Per IGBT)			1.25	1.4	K/W	

Diode-Brake chopper

ELECTRICAL CHARACTERISTICS ($T_C=25^\circ\text{C}$ unless otherwise specified)

Symbol	Parameter/Test Conditions		Min.	Typ.	Max.	Unit
V_F	Forward Voltage	$I_F=10\text{A}, V_{GE}=0\text{V}, T_J=25^\circ\text{C}$		1.95	2.45	V
		$I_F=10\text{A}, V_{GE}=0\text{V}, T_J=125^\circ\text{C}$		1.55		
		$I_F=10\text{A}, V_{GE}=0\text{V}, T_J=150^\circ\text{C}$		1.5		
t_{rr}	Reverse Recovery Time	$I_F=10\text{A}, V_R=600\text{V}$ $di_F/dt=-500\text{A}/\mu\text{s}$ $T_J=150^\circ\text{C}$		161		ns
I_{RRM}	Max. Reverse Recovery Current			15		A
Q_{RR}	Reverse Recovery Charge			1.6		μC
E_{rec}	Reverse Recovery Energy			0.57		mJ
R_{thJCD}	Junction to Case Thermal Resistance (Per Diode)			1.75	1.9	K/W

MMG10CB120XB6TC

NTC CHARACTERISTICS ($T_C=25^\circ\text{C}$ unless otherwise specified)

Symbol	Parameter/Test Conditions	Min.	Typ.	Max.	Unit
R_{25}	Resistance $T_C=25^\circ\text{C}$		5		K Ω
$B_{25/50}$	$R_2 = R_{25} \exp [B_{25/50}(1/T_2 - 1/(298.15 \text{ K}))]$		3375		K

MODULE CHARACTERISTICS ($T_C=25^\circ\text{C}$ unless otherwise specified)

Symbol	Parameter/Test Conditions	Values	Unit
T_{Jmax}	Max. Junction Temperature	Inverter, Brake-Chopper	175
		Rectifier	150
T_{Jop}	Operating Temperature	-40~150	$^\circ\text{C}$
T_{stg}	Storage Temperature	-40~125	
V_{isol}	Isolation Breakdown Voltage AC, 50Hz(R.M.S), t=1 minute	3000	V
CTI	Comparative Tracking Index	>200	
F	Mounting Force Per Clamp	20~50	N
Weight		25	g

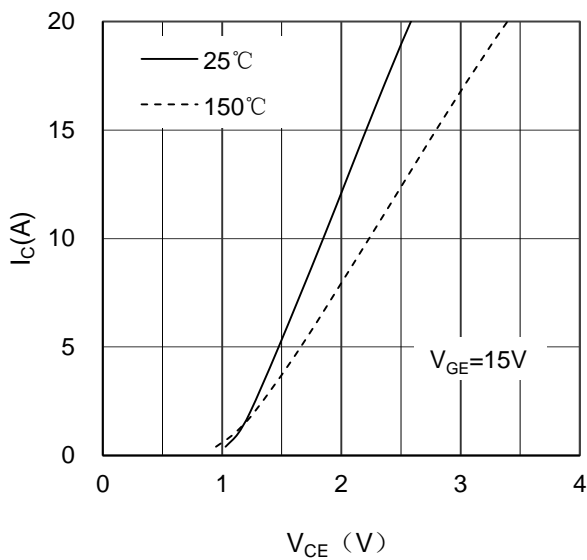

Figure 1. Typical Output Characteristics IGBT-inverter

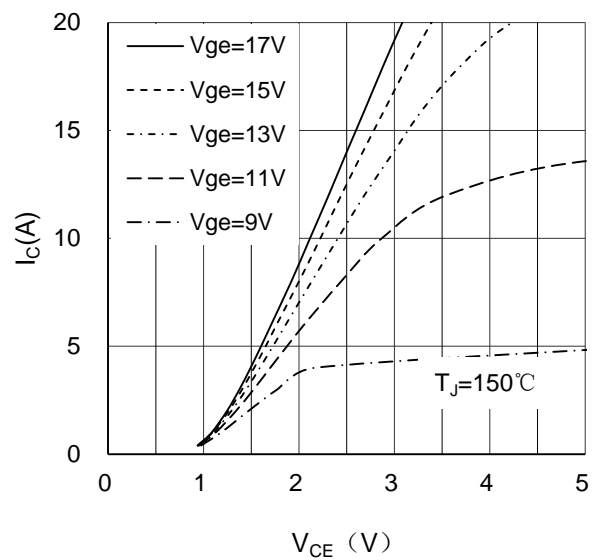

Figure 2. Typical Output Characteristics IGBT-inverter

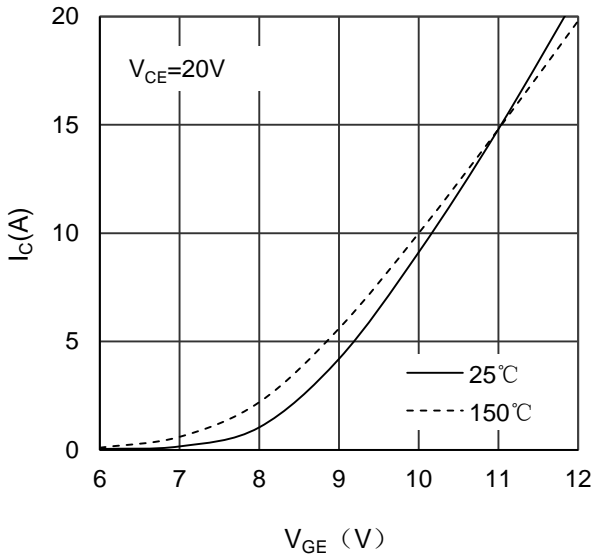

Figure 3. Typical Transfer characteristics IGBT-inverter

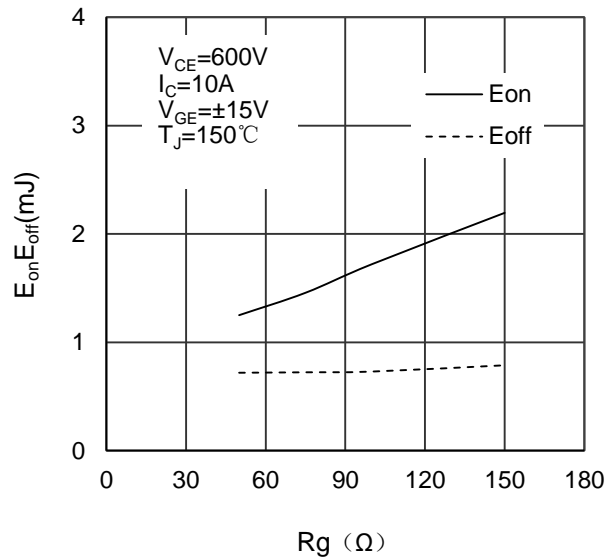

Figure 4. Switching Energy vs Gate Resistor IGBT-inverter

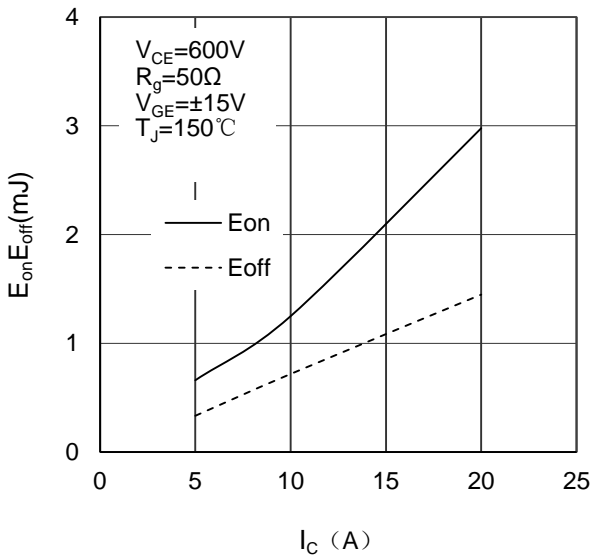

Figure 5. Switching Energy vs Collector Current IGBT-inverter

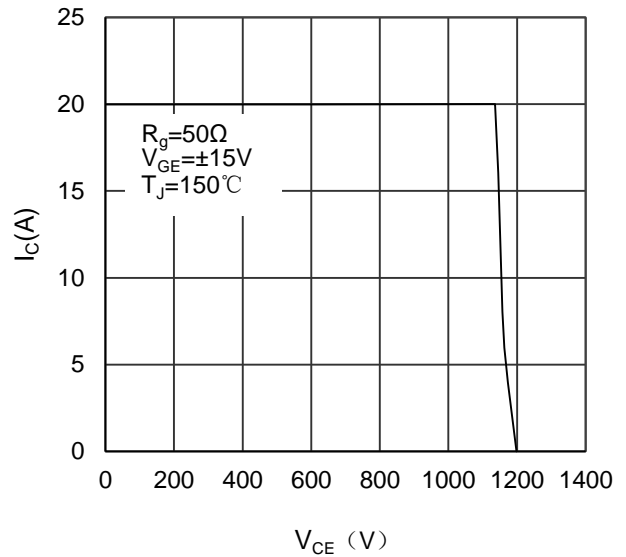

Figure 6. Reverse Biased Safe Operating Area IGBT-inverter

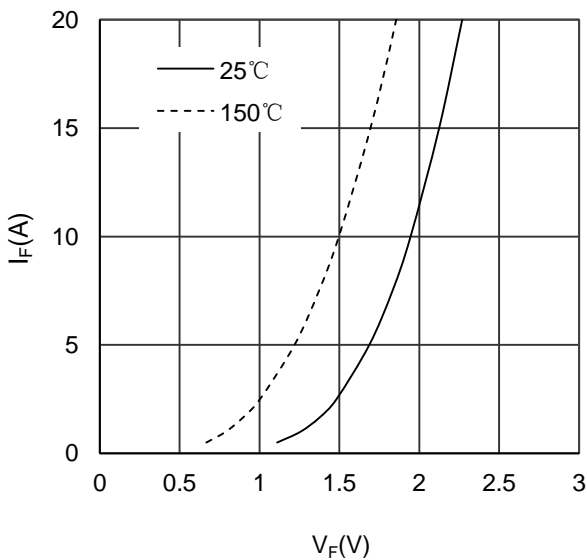

Figure 7. Diode Forward Characteristics Diode -inverter

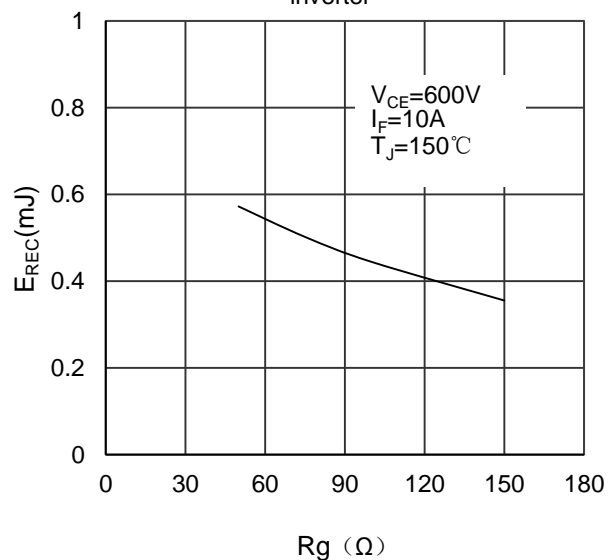

Figure 8. Switching Energy vs Gate Resistor Diode -inverter

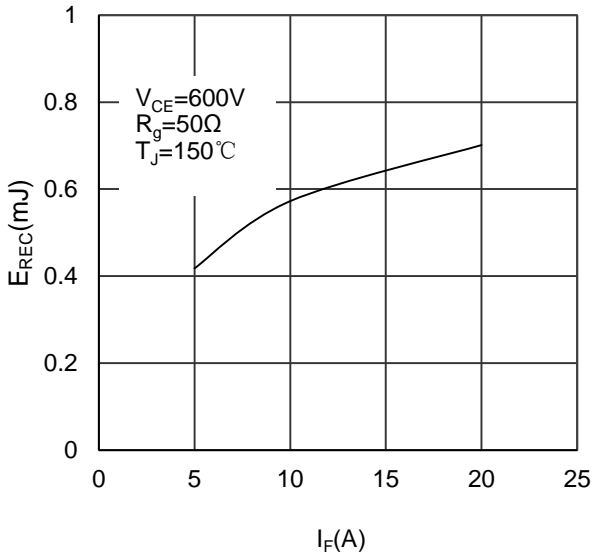

Figure 9. Switching Energy vs Forward Current Diode-inverter

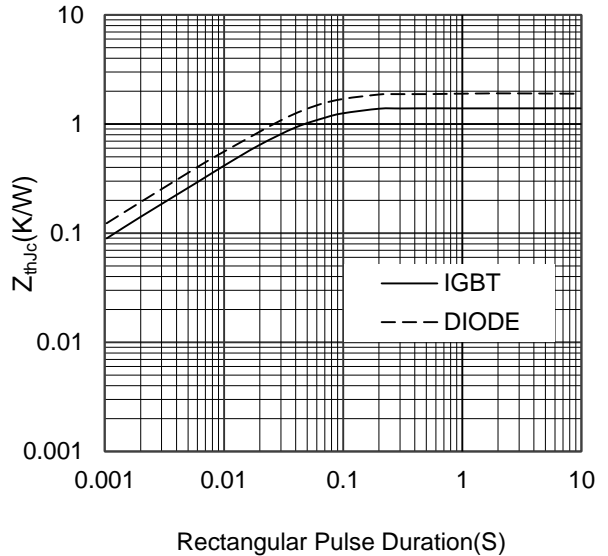

Figure 10. Transient Thermal Impedance of Diode and IGBT-inverter

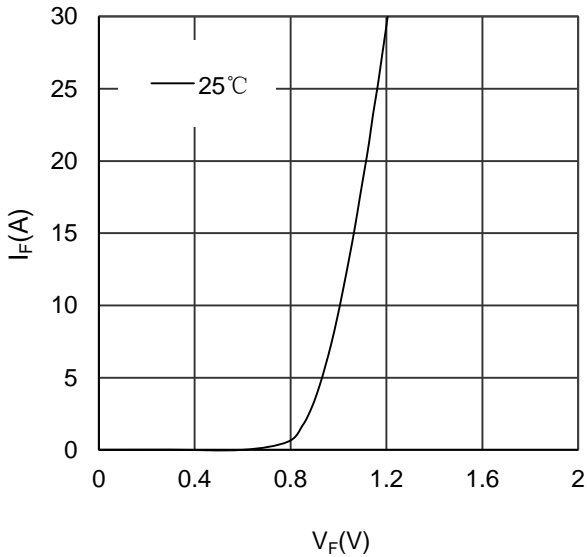

Figure 11. Diode Forward Characteristics Diode-rectifier

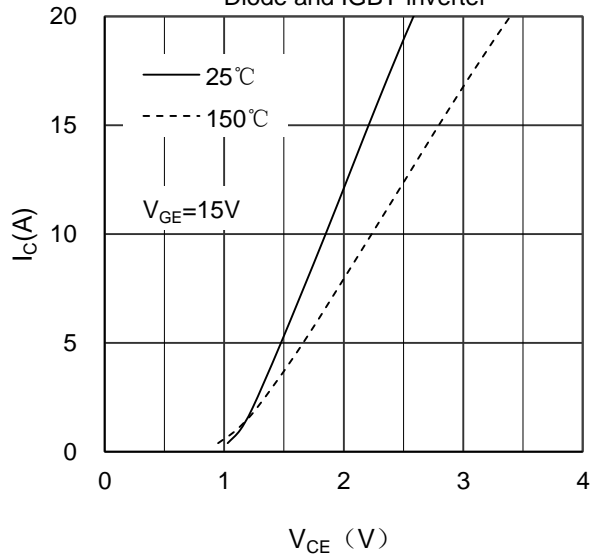

Figure 12. Typical Output Characteristics IGBT-brake chopper

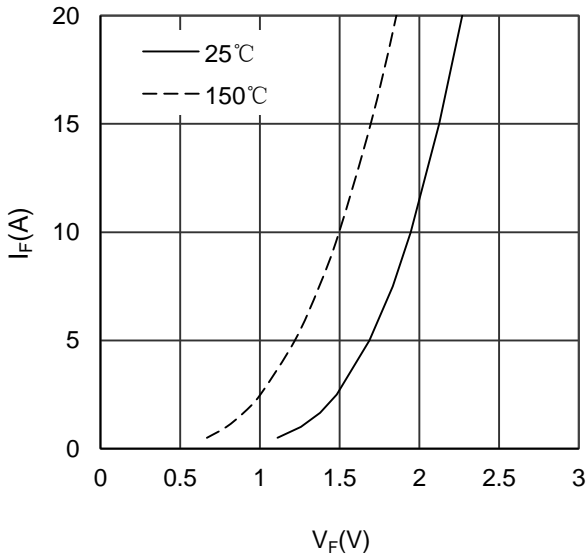

Figure 13. Diode Forward Characteristics Diode-brake chopper

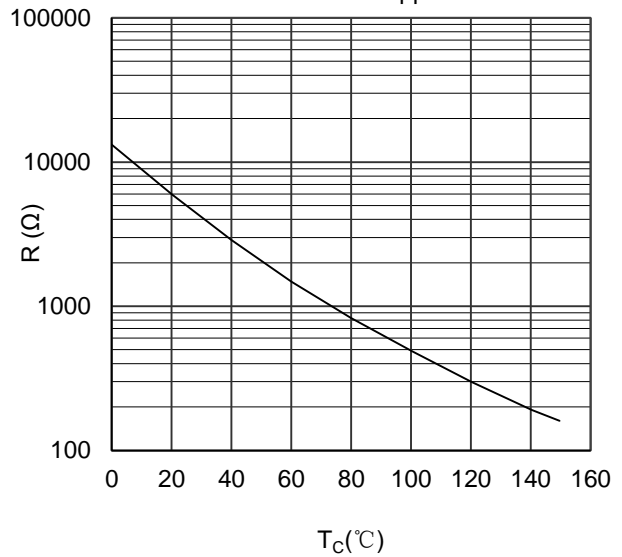

Figure 14. NTC Characteristics

MMG10CB120XB6TC

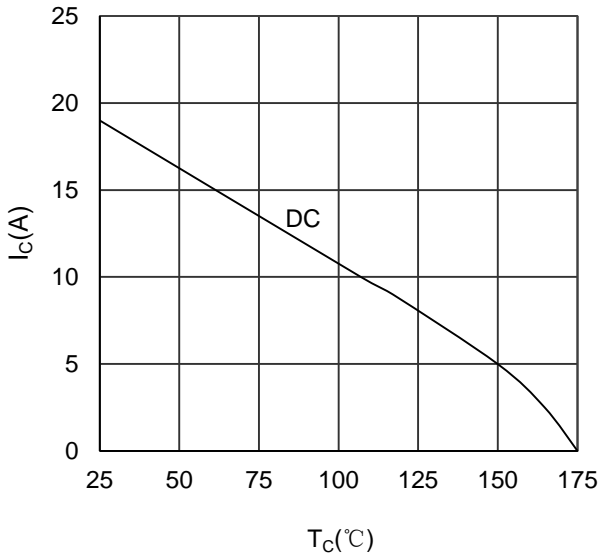

Figure 15. Collector Current vs Case temperature IGBT-inverter

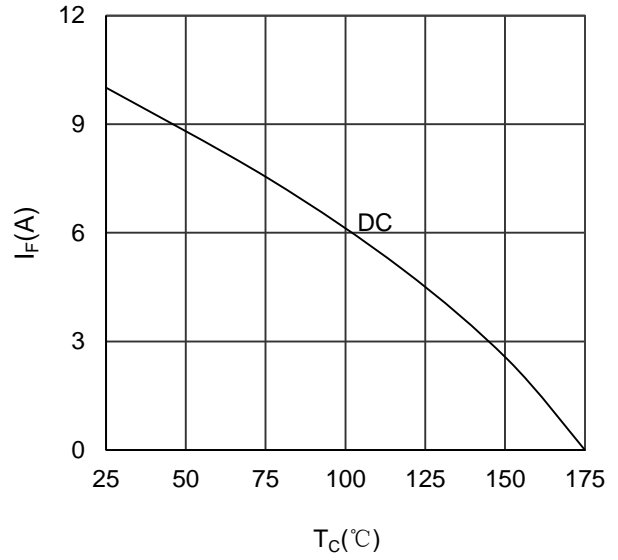

Figure 16. Forward current vs Case temperature Diode-inverter

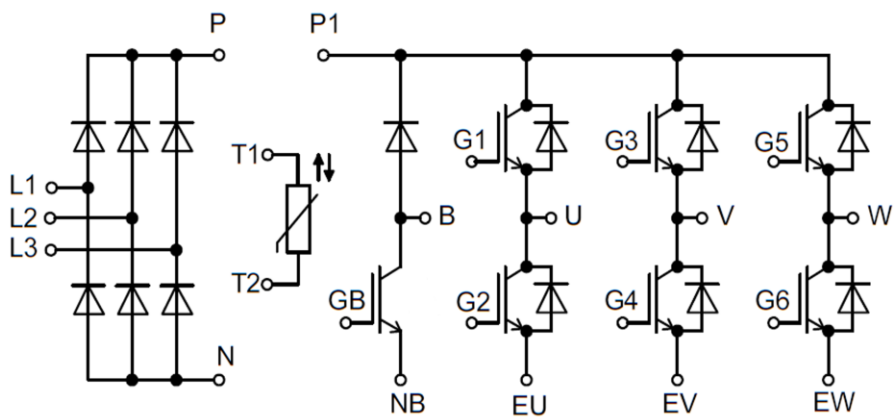
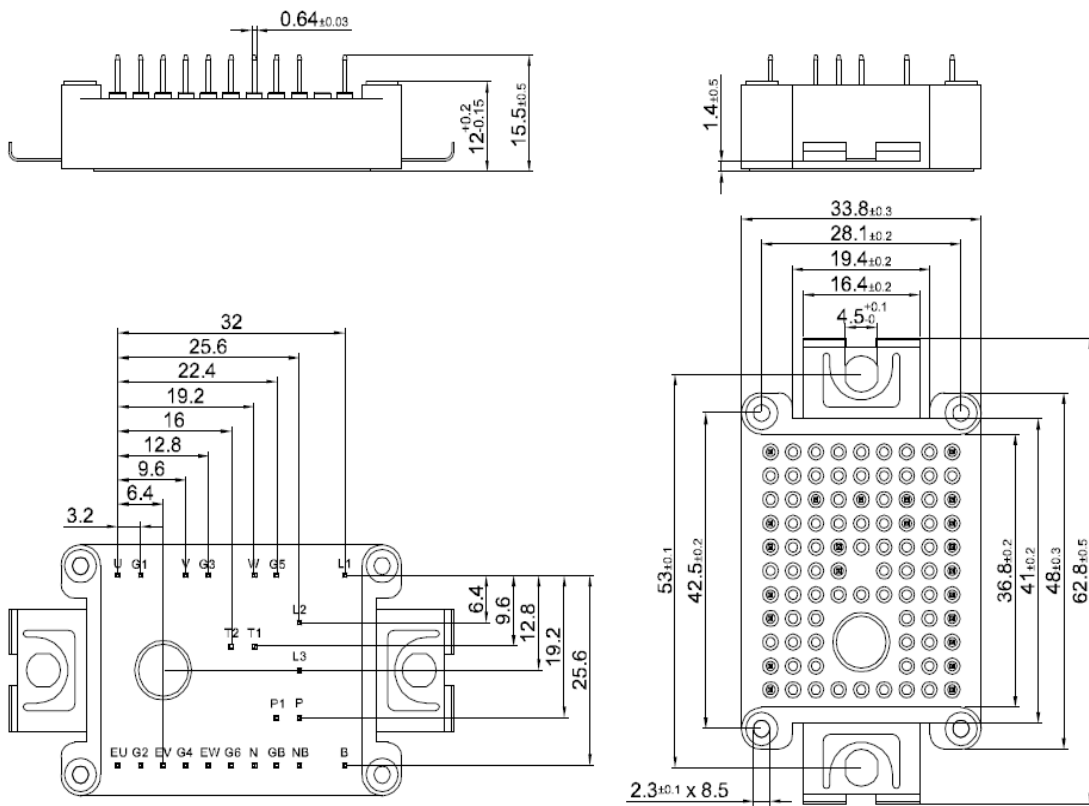

Figure 17. Circuit Diagram



Dimensions in (mm)

Figure 18. Package Outline