

## PRODUCT FEATURES

- IGBT CHIP(Trench+Field Stop technology)
- $V_{CE(sat)}$  with positive temperature coefficient
- High short circuit capability
- Fast switching and short tail current
- Free wheeling diodes with fast and soft reverse recovery
- Low switching losses



## APPLICATIONS

- High frequency switching application
- Medical applications
- Motion/servo control
- UPS systems

### IGBT-inverter

ABSOLUTE MAXIMUM RATINGS( $T_C=25^\circ\text{C}$  unless otherwise specified)

Symbol	Parameter/Test Conditions		Values	Unit
$V_{CES}$	Collector Emitter Voltage	$T_J=25^\circ\text{C}$	1200	V
$V_{GES}$	Gate Emitter Voltage		$\pm 20$	
$I_C$	DC Collector Current	$T_C=25^\circ\text{C}, T_{Jmax}=175^\circ\text{C}$	228	A
		$T_C=100^\circ\text{C}, T_{Jmax}=175^\circ\text{C}$	150	
$I_{CM}$	Repetitive Peak Collector Current	$tp=1\text{ms}$	300	
$P_{tot}$	Power Dissipation Per IGBT	$T_C=25^\circ\text{C}, T_{Jmax}=175^\circ\text{C}$	789	W

### Diode-inverter

ABSOLUTE MAXIMUM RATINGS ( $T_C=25^\circ\text{C}$  unless otherwise specified)

Symbol	Parameter/Test Conditions		Values	Unit
$V_{RRM}$	Repetitive Reverse Voltage	$T_J=25^\circ\text{C}$	1200	V
$I_{F(AV)}$	Average Forward Current		150	A
$I_{FRM}$	Repetitive Peak Forward Current	$tp=1\text{ms}$	300	
$I^2t$		$T_J=125^\circ\text{C}, t=10\text{ms}, V_R=0\text{V}$	6050	$\text{A}^2\text{S}$

MacMic Science & Technology Co., Ltd.

Add: #18, Hua Shan Zhong Lu, New District, Changzhou City, Jiangsu Province, P. R .of China

# MMG150D120B6TC

## IGBT-inverter

### ELECTRICAL CHARACTERISTICS ( $T_C=25^\circ\text{C}$ unless otherwise specified)

Symbol	Parameter/Test Conditions		Min.	Typ.	Max.	Unit	
$V_{GE(th)}$	Gate Emitter Threshold Voltage	$V_{CE}=V_{GE}, I_C=6\text{mA}$	5.0	5.8	6.5	V	
$V_{CE(sat)}$	Collector - Emitter Saturation Voltage	$I_C=150\text{A}, V_{GE}=15\text{V}, T_J=25^\circ\text{C}$		1.8	2.25		
		$I_C=150\text{A}, V_{GE}=15\text{V}, T_J=125^\circ\text{C}$		2.1			
		$I_C=150\text{A}, V_{GE}=15\text{V}, T_J=150^\circ\text{C}$		2.15			
$I_{CES}$	Collector Leakage Current	$V_{CE}=1200\text{V}, V_{GE}=0\text{V}, T_J=25^\circ\text{C}$			1	mA	
		$V_{CE}=1200\text{V}, V_{GE}=0\text{V}, T_J=150^\circ\text{C}$			10		
$I_{GES}$	Gate Leakage Current	$V_{CE}=0\text{V}, V_{GE}=\pm 20\text{V}, T_J=25^\circ\text{C}$	-400		400	nA	
$R_{gint}$	Integrated Gate Resistor			3.5		$\Omega$	
$Q_g$	Gate Charge	$V_{CE}=600\text{V}, I_C=150\text{A}, V_{GE}=15\text{V}$		0.82		$\mu\text{C}$	
$C_{ies}$	Input Capacitance	$V_{CE}=25\text{V}, V_{GE}=0\text{V}, f=1\text{MHz}$		9.8		nF	
$C_{res}$	Reverse Transfer Capacitance				440		pF
$t_{d(on)}$	Turn on Delay Time	$V_{CC}=600\text{V}, I_C=150\text{A}$ $R_G=3.3\Omega,$ $V_{GE}=\pm 15\text{V},$ Inductive Load	$T_J=25^\circ\text{C}$	100		ns	
			$T_J=125^\circ\text{C}$	124		ns	
			$T_J=150^\circ\text{C}$	130		ns	
$t_r$	Rise Time		$T_J=25^\circ\text{C}$	54		ns	
			$T_J=125^\circ\text{C}$	58		ns	
			$T_J=150^\circ\text{C}$	60		ns	
$t_{d(off)}$	Turn off Delay Time	$T_J=25^\circ\text{C}$	300		ns		
		$T_J=125^\circ\text{C}$	350		ns		
		$T_J=150^\circ\text{C}$	360		ns		
$t_f$	Fall Time	$T_J=25^\circ\text{C}$	100		ns		
		$T_J=125^\circ\text{C}$	180		ns		
		$T_J=150^\circ\text{C}$	200		ns		
$E_{on}$	Turn on Energy	$V_{CC}=600\text{V}, I_C=150\text{A}$ $R_G=3.3\Omega,$ $V_{GE}=\pm 15\text{V},$ Inductive Load	$T_J=125^\circ\text{C}$	24		mJ	
			$T_J=150^\circ\text{C}$	26.5		mJ	
$E_{off}$	Turn off Energy		$T_J=125^\circ\text{C}$	12.4		mJ	
			$T_J=150^\circ\text{C}$	13.4		mJ	
$I_{SC}$	Short Circuit Current		$tpsc \leq 10\mu\text{S}, V_{GE}=15\text{V}$ $T_J=125^\circ\text{C}, V_{CC}=800\text{V}$		600		A
$R_{thJC}$	Junction to Case Thermal Resistance (Per IGBT)				0.19	K/W	

## Diode-inverter

### ELECTRICAL CHARACTERISTICS ( $T_C=25^\circ\text{C}$ unless otherwise specified)

Symbol	Parameter/Test Conditions		Min.	Typ.	Max.	Unit
$V_F$	Forward Voltage	$I_F=150\text{A}, V_{GE}=0\text{V}, T_J=25^\circ\text{C}$		1.75	2.15	V
		$I_F=150\text{A}, V_{GE}=0\text{V}, T_J=125^\circ\text{C}$		1.55		
		$I_F=150\text{A}, V_{GE}=0\text{V}, T_J=150^\circ\text{C}$		1.50		
$t_{rr}$	Reverse Recovery Time	$I_F=150\text{A}, V_R=600\text{V}$ $dI_F/dt=-3700\text{A}/\mu\text{s}$ $T_J=150^\circ\text{C}$		550		ns
$I_{RRM}$	Max. Reverse Recovery Current			165		A
$Q_{RR}$	Reverse Recovery Charge			37.6		$\mu\text{C}$
$E_{rec}$	Reverse Recovery Energy			12.6		mJ
$R_{thJCD}$	Junction to Case Thermal Resistance (Per Diode)				0.3	K/W

# MMG150D120B6TC

## MODULE CHARACTERISTICS ( $T_C=25^\circ\text{C}$ unless otherwise specified)

Symbol	Parameter/Test Conditions		Values	Unit
$T_{Jmax}$	Max. Junction Temperature		175	$^\circ\text{C}$
$T_{Jop}$	Operating Temperature		-40~150	
$T_{stg}$	Storage Temperature		-40~125	
$V_{isol}$	Isolation Breakdown Voltage	AC, 50Hz(R.M.S), t=1minute	3000	V
CTI	Comparative Tracking Index		> 225	
Torque	to heatsink	Recommended (M6)	3~5	Nm
	to terminal	Recommended (M6)	2.5~5	Nm
Weight			300	g

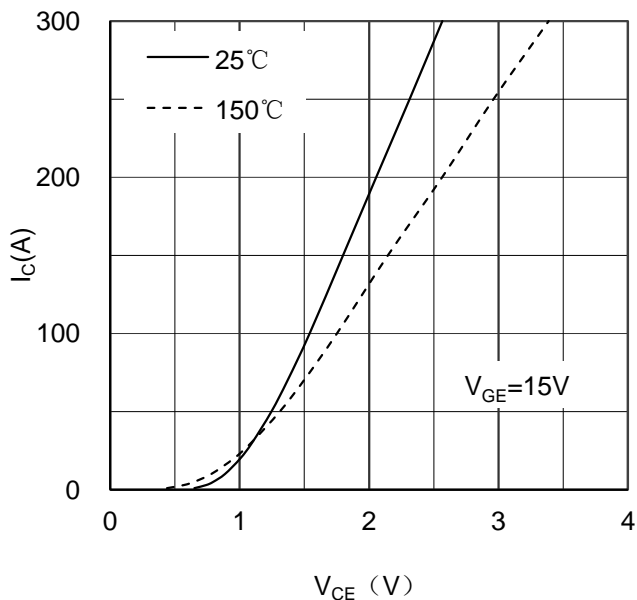

Figure 1. Typical Output Characteristics IGBT-inverter

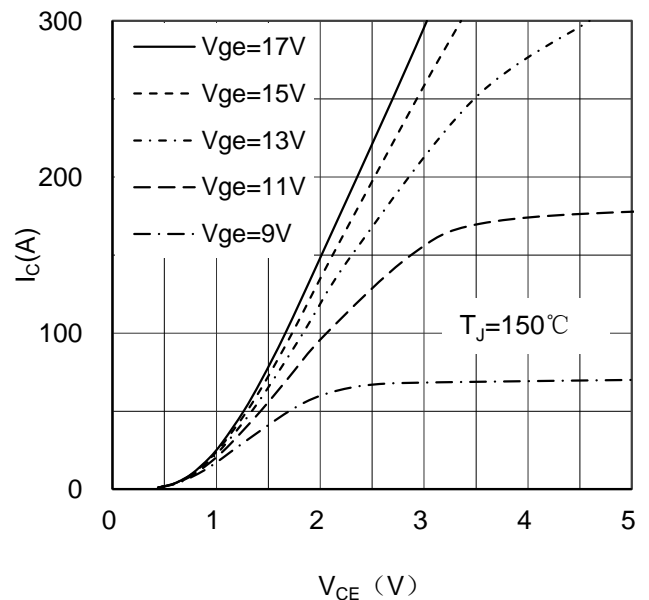

Figure 2. Typical Output Characteristics IGBT-inverter

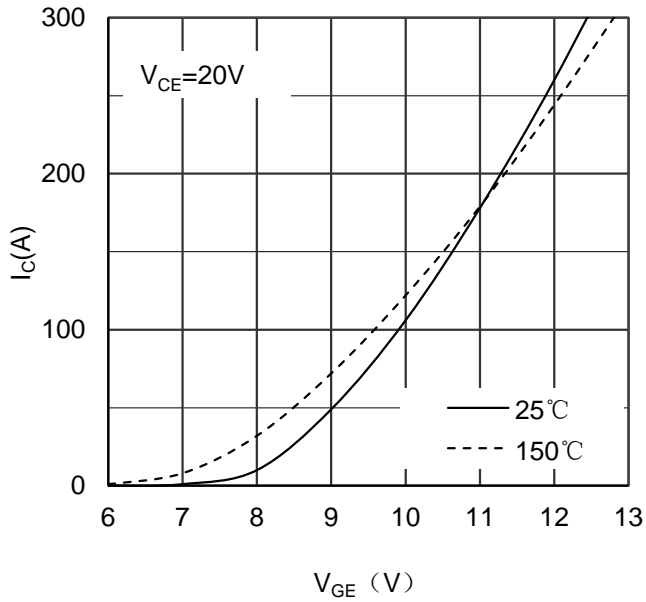

Figure 3. Typical Transfer characteristics IGBT-inverter

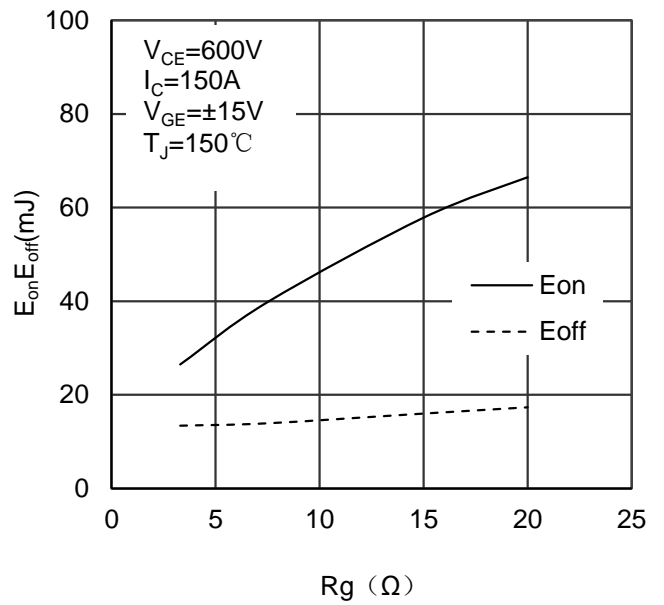

Figure 4. Switching Energy vs Gate Resistor IGBT-inverter

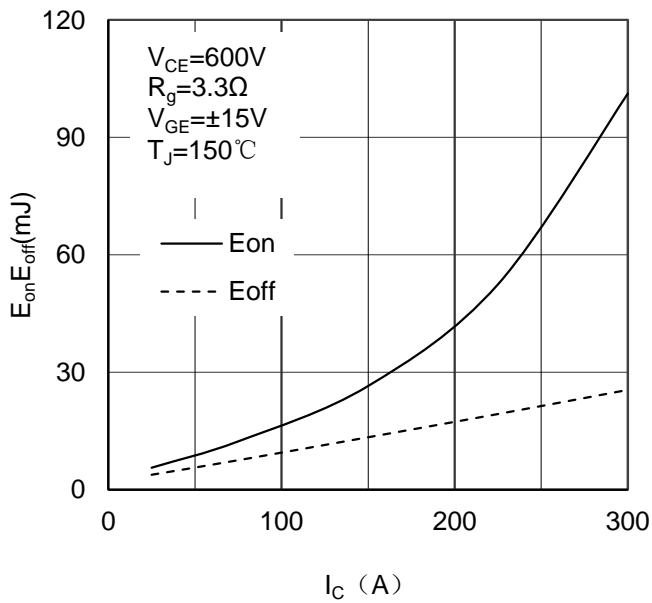

Figure 5. Switching Energy vs Collector Current IGBT-inverter

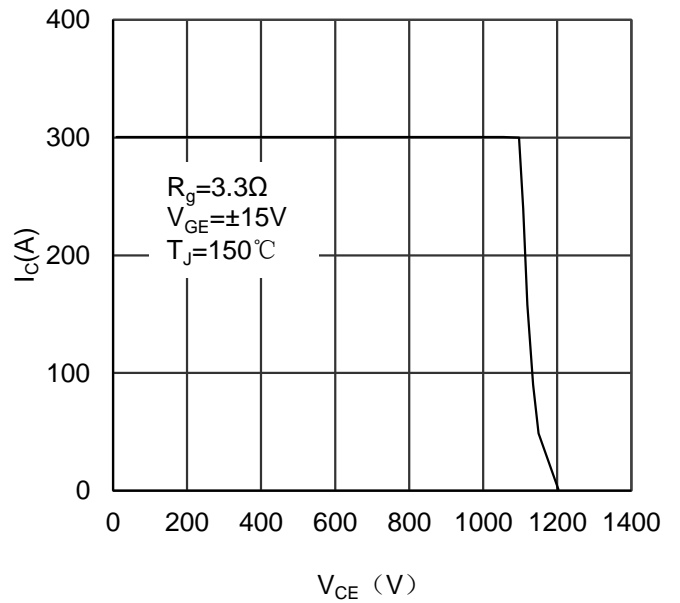

Figure 6. Reverse Biased Safe Operating Area IGBT-inverter

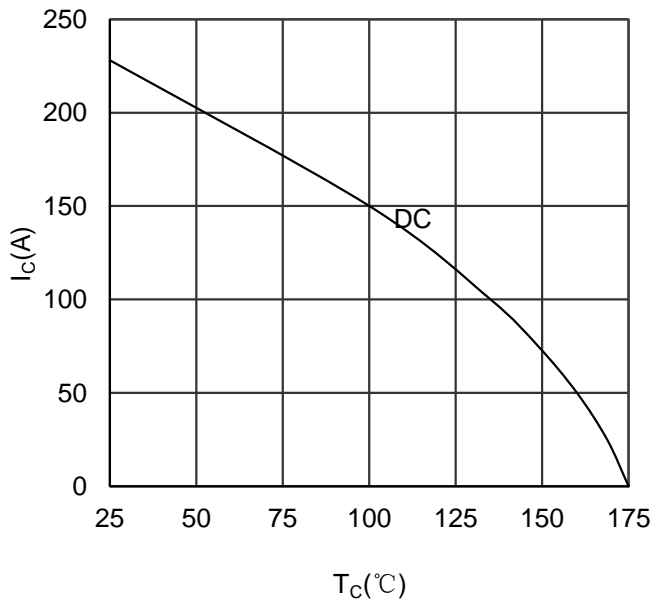

Figure 7. Collector Current vs Case temperature IGBT-inverter

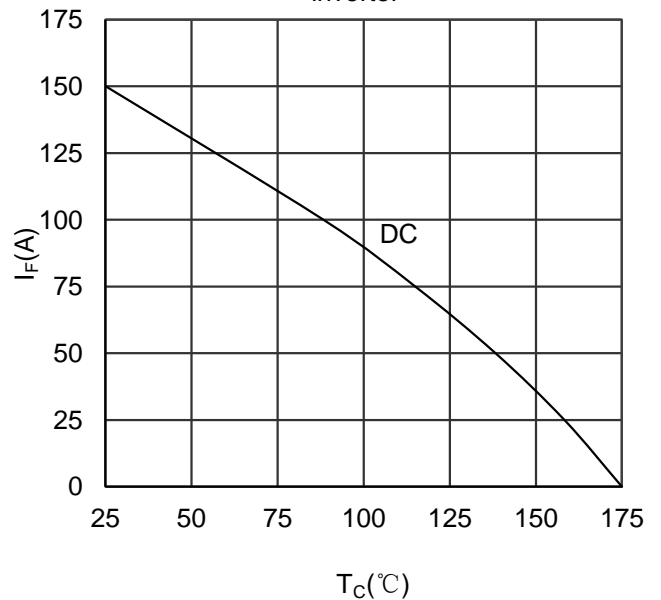

Figure 8. Forward current vs Case temperature Diode-inverter

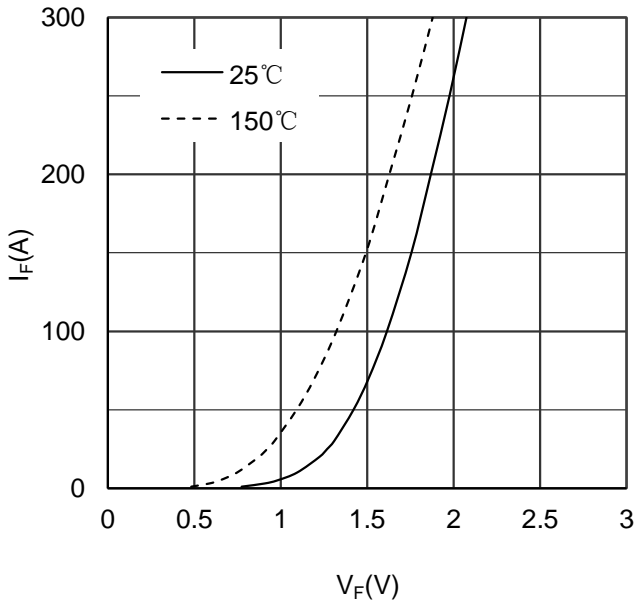

Figure 9. Diode Forward Characteristics Diode-inverter

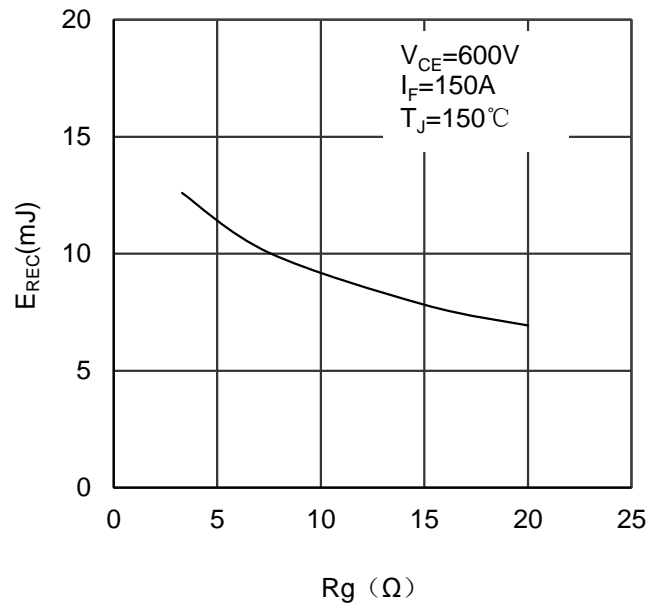

Figure 10. Switching Energy vs Gate Resistor Diode-inverter

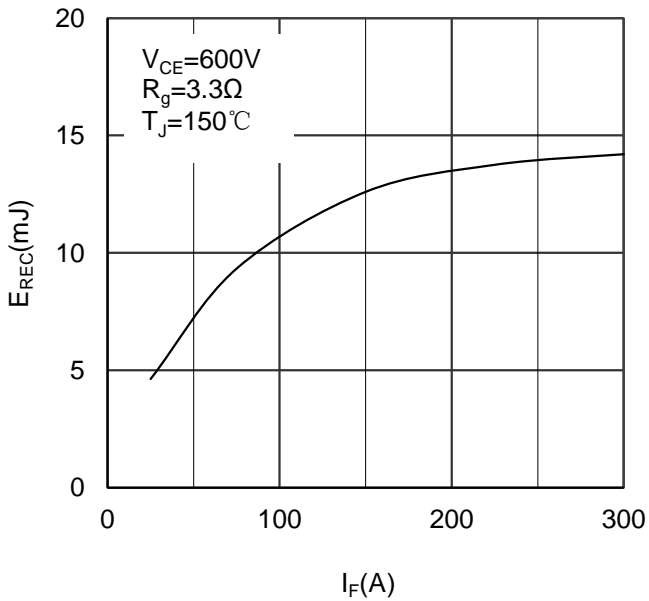

Figure 11. Switching Energy vs Forward Current Diode-inverter

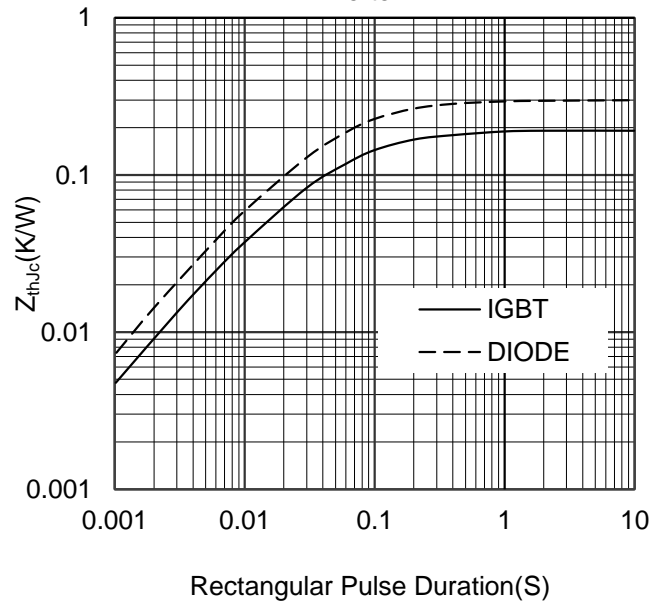

Figure 12. Transient Thermal Impedance of Diode and IGBT-inverter

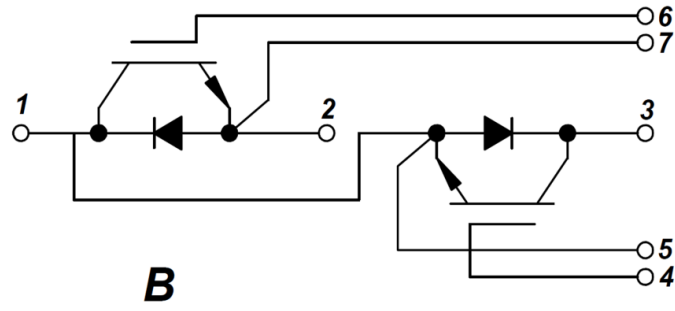
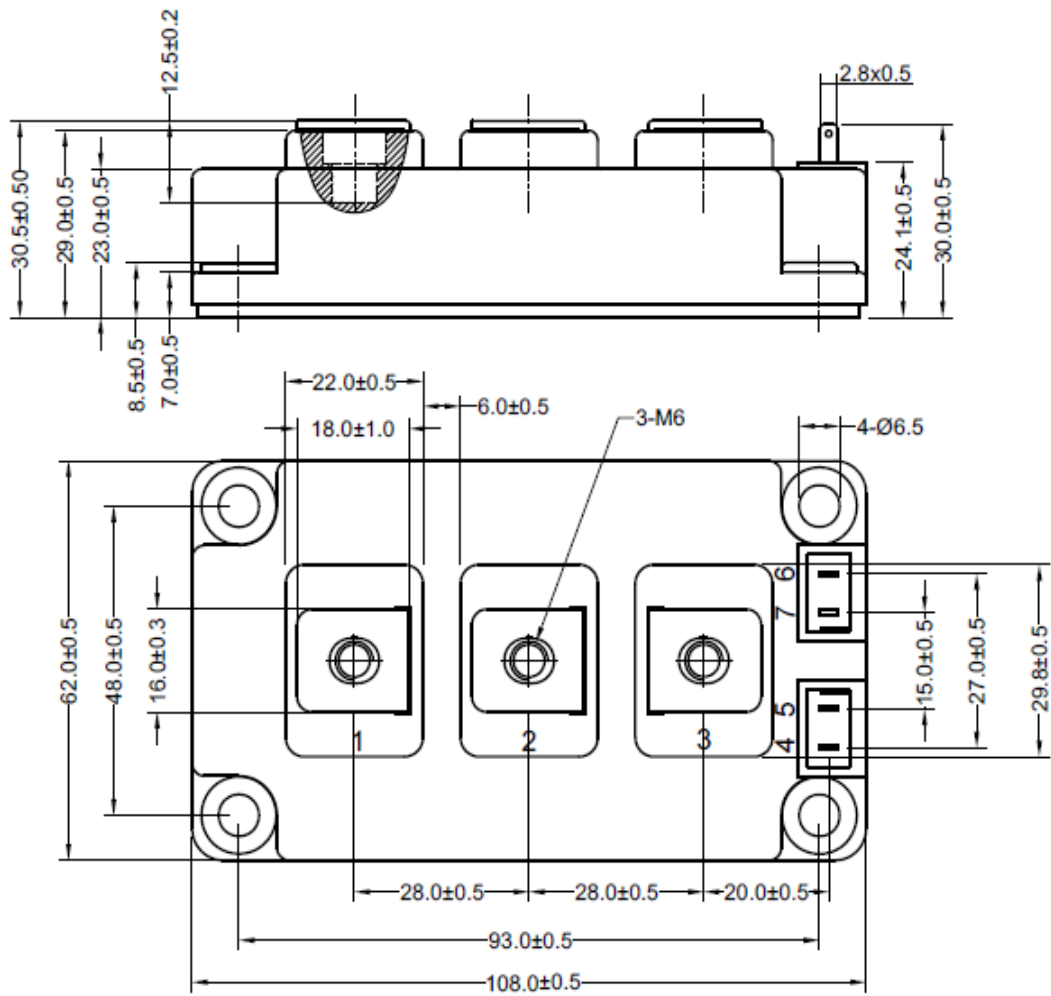

Figure 13. Circuit Diagram



Dimensions in (mm)

Figure 14. Package Outline