

PRODUCT FEATURES

- 650V IGBT CHIP(Trench+Field Stop technology)
- Low saturation voltage and positive temperature coefficient
- Low switching losses and short tail current
- Free wheeling diodes with fast and soft reverse recovery
- Temperature sense included

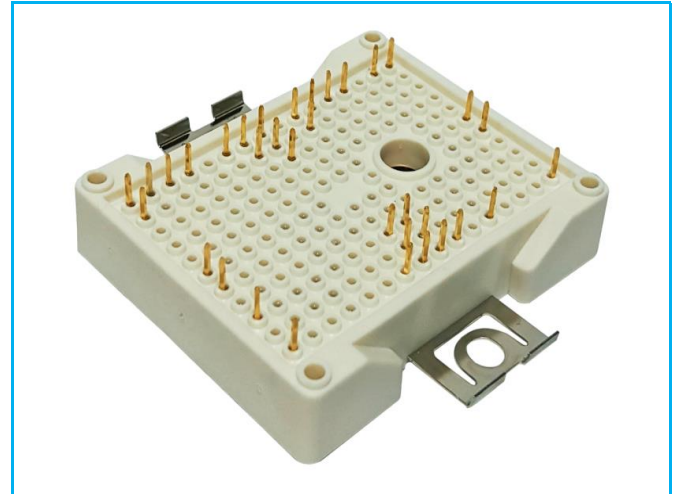

APPLICATIONS

- 3-Level-Applications
- Solar Applications
- UPS Systems

IGBT(T1、 T2、 T3、 T4)

ABSOLUTE MAXIMUM RATINGS($T_C=25^{\circ}\text{C}$ unless otherwise specified)

Symbol	Parameter/Test Conditions		Values	Unit
V_{CES}	Collector Emitter Voltage	$T_J=25^{\circ}\text{C}$	650	V
V_{GES}	Gate Emitter Voltage		± 20	
I_C	DC Collector Current	$T_C=25^{\circ}\text{C}, T_{Jmax}=175^{\circ}\text{C}$	150	A
I_{CM}	Repetitive Peak Collector Current	$t_p=1\text{ms}$	300	
P_{tot}	Power Dissipation Per IGBT	$T_C=25^{\circ}\text{C}, T_{Jmax}=175^{\circ}\text{C}$	335	W

Diode(D1、 D2、 D3、 D4、 D5、 D6)

ABSOLUTE MAXIMUM RATINGS ($T_C=25^{\circ}\text{C}$ unless otherwise specified)

Symbol	Parameter/Test Conditions		Values	Unit
V_{RRM}	Repetitive Reverse Voltage	$T_J=25^{\circ}\text{C}$	650	V
$I_{F(AV)}$	Average Forward Current		150	A
I_{FRM}	Repetitive Peak Forward Current	$t_p=1\text{ms}$	300	
I^2t		$T_J=125^{\circ}\text{C}, t=10\text{ms}, V_R=0\text{V}$	1700	A^2s

MacMic Science & Technology Co., Ltd.

Add: #18, Hua Shan Zhong Lu, New District, Changzhou City, Jiangsu Province, P. R .of China

Tel.: +86-519-85163708 Fax: +86-519-85162291 Post Code: 213022 Website: www.macmicst.com

MMG150CE065PD6T6

IGBT(T1、T2、T3、T4)

ELECTRICAL CHARACTERISTICS ($T_C=25^\circ\text{C}$ unless otherwise specified)

Symbol	Parameter/Test Conditions		Min.	Typ.	Max.	Unit	
$V_{GE(th)}$	Gate Emitter Threshold Voltage	$V_{CE}=V_{GE}, I_C=2.4\text{mA}$	5.2	5.6	6.1	V	
$V_{CE(sat)}$	Collector Emitter Saturation Voltage	$I_C=150\text{A}, V_{GE}=15\text{V}, T_J=25^\circ\text{C}$		1.4	1.8		
		$I_C=150\text{A}, V_{GE}=15\text{V}, T_J=150^\circ\text{C}$		1.55			
I_{CES}	Collector Leakage Current	$V_{CE}=650\text{V}, V_{GE}=0\text{V}, T_J=25^\circ\text{C}$			1	mA	
		$V_{CE}=650\text{V}, V_{GE}=0\text{V}, T_J=150^\circ\text{C}$			5		
I_{GES}	Gate Leakage Current	$V_{CE}=0\text{V}, V_{GE}=\pm 20\text{V}, T_J=25^\circ\text{C}$	-400		400	nA	
R_{Gint}	Integrated Gate Resistor			2		Ω	
Q_G	Gate Charge	$V_{CE}=300\text{V}, I_C=150\text{A}, V_{GE}=15\text{V}$		0.7		μC	
C_{ies}	Input Capacitance	$V_{CE}=25\text{V}, V_{GE}=0\text{V}, f=1\text{MHz}$		9		nF	
C_{res}	Reverse Transfer Capacitance				350		pF
$t_{d(on)}$	Turn on Delay Time	$V_{CC}=300\text{V}, I_C=150\text{A}$ $R_G=5.1\Omega,$ $V_{GE}=\pm 15\text{V},$ Inductive Load	$T_J=25^\circ\text{C}$		60		ns
			$T_J=150^\circ\text{C}$		65		ns
t_r	Rise Time		$T_J=25^\circ\text{C}$		65		ns
			$T_J=150^\circ\text{C}$		70		ns
$t_{d(off)}$	Turn off Delay Time	$V_{CC}=300\text{V}, I_C=150\text{A}$ $R_G=5.1\Omega,$ $V_{GE}=\pm 15\text{V},$ Inductive Load	$T_J=25^\circ\text{C}$		350		ns
			$T_J=150^\circ\text{C}$		390		ns
t_f	Fall Time		$T_J=25^\circ\text{C}$		70		ns
			$T_J=150^\circ\text{C}$		100		ns
E_{on}	Turn on Energy	$V_{CC}=300\text{V}, I_C=150\text{A}$ $R_G=5.1\Omega,$ $V_{GE}=\pm 15\text{V},$ Inductive Load	$T_J=25^\circ\text{C}$		2.4		mJ
			$T_J=150^\circ\text{C}$		3.6		mJ
E_{off}	Turn off Energy		$T_J=25^\circ\text{C}$		3.9		mJ
			$T_J=150^\circ\text{C}$		5		mJ
I_{SC}	Short Circuit Current	$tp_{sc}\leq 6\mu\text{s}, V_{GE}=15\text{V}$ $T_J=125^\circ\text{C}, V_{CC}=360\text{V}$		1000		A	
R_{thJC}	Junction to Case Thermal Resistance (Per IGBT)			0.4	0.45	K/W	

Diode(D1、D2、D3、D4、D5、D6)

ELECTRICAL CHARACTERISTICS ($T_C=25^\circ\text{C}$ unless otherwise specified)

Symbol	Parameter/Test Conditions		Min.	Typ.	Max.	Unit
V_F	Forward Voltage	$I_F=150\text{A}, V_{GE}=0\text{V}, T_J=25^\circ\text{C}$		1.55	1.95	V
		$I_F=150\text{A}, V_{GE}=0\text{V}, T_J=150^\circ\text{C}$		1.45		
t_{rr}	Reverse Recovery Time	$I_F=150\text{A}, V_R=300\text{V}$ $dI_F/dt=-2600\text{A}/\mu\text{s}$ $T_J=150^\circ\text{C}$		200		ns
I_{RRM}	Max. Reverse Recovery Current			125		A
Q_{RR}	Reverse Recovery Charge			11.8		μC
E_{rec}	Reverse Recovery Energy			4		mJ
R_{thJCD}	Junction to Case Thermal Resistance (Per Diode)				0.55	K/W

MMG150CE065PD6T6

NTC CHARACTERISTICS ($T_C=25^\circ\text{C}$ unless otherwise specified)

Symbol	Parameter/Test Conditions	Min.	Typ.	Max.	Unit
R_{25}	Resistance $T_C=25^\circ\text{C}$		5		k Ω
$B_{25/50}$	$R_2 = R_{25} \exp [B_{25/50}(1/T_2 - 1/(298.15 \text{ K}))]$		3375		K

MODULE CHARACTERISTICS ($T_C=25^\circ\text{C}$ unless otherwise specified)

Symbol	Parameter/Test Conditions	Values	Unit	
T_{Jmax}	Max. Junction Temperature	175	°C	
T_{Jop}	Operating Temperature	-40~150		
T_{stg}	Storage Temperature	-40~125		
V_{isol}	Isolation Breakdown Voltage	AC, 50Hz(R.M.S), t=1minute	3000	V
CTI	Comparative Tracking Index		> 200	
F	Mounting Force Per Clamp		40~80	N
Weight			42.9	g

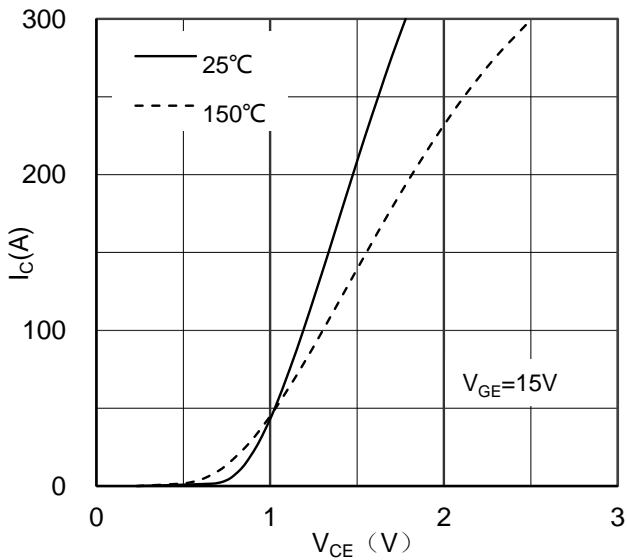

Figure 1. Typical Output Characteristics IGBT

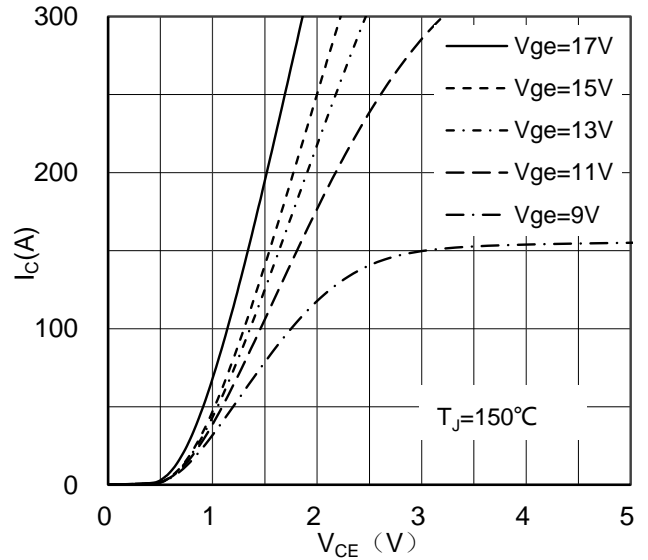

Figure 2. Typical Output Characteristics IGBT

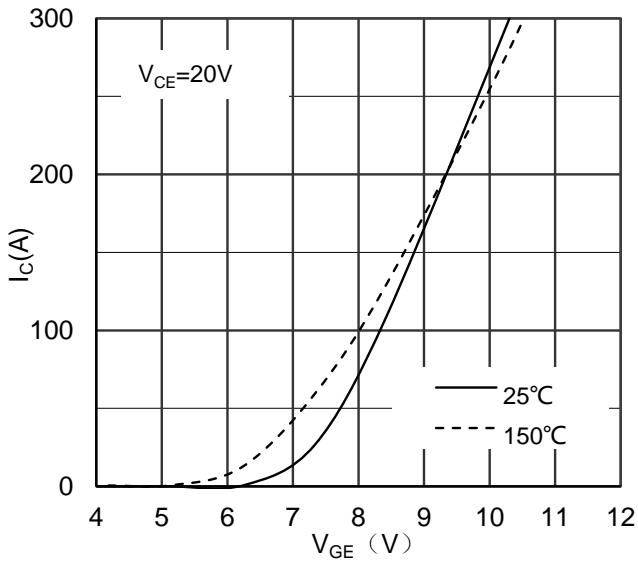

Figure 3. Typical Transfer characteristics IGBT

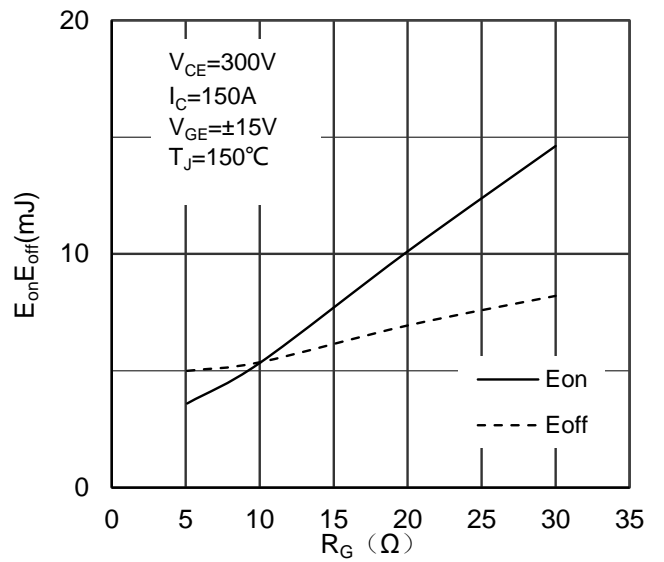

Figure 4. Switching Energy vs Gate Resistor IGBT

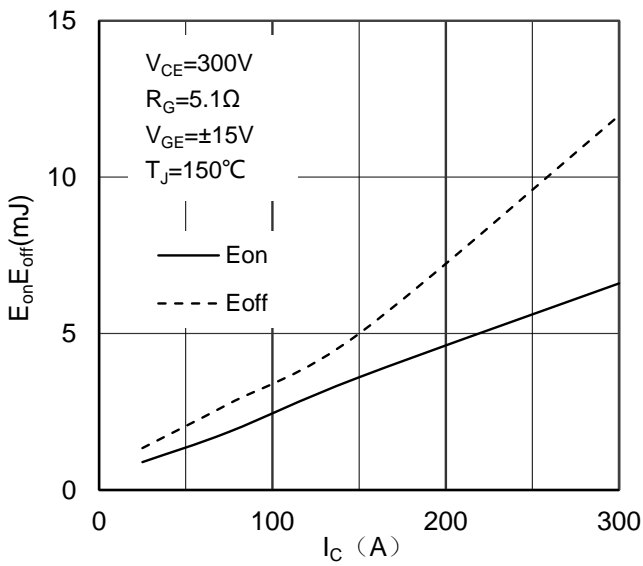

Figure 5. Switching Energy vs Collector Current IGBT

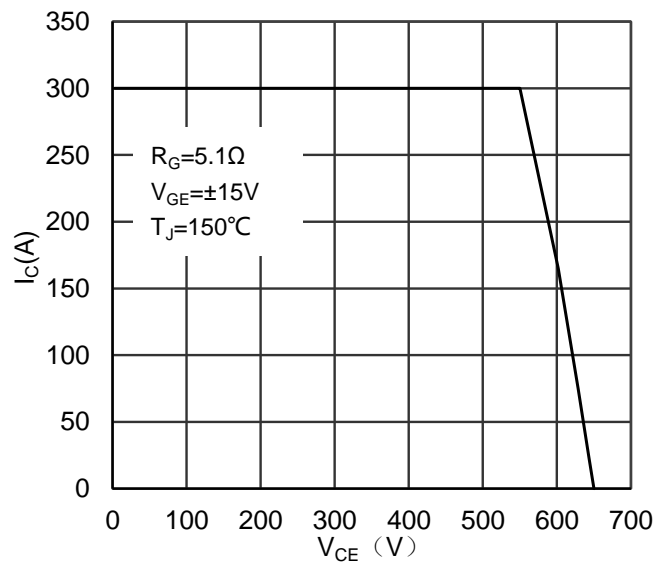

Figure 6. Reverse Biased Safe Operating Area IGBT

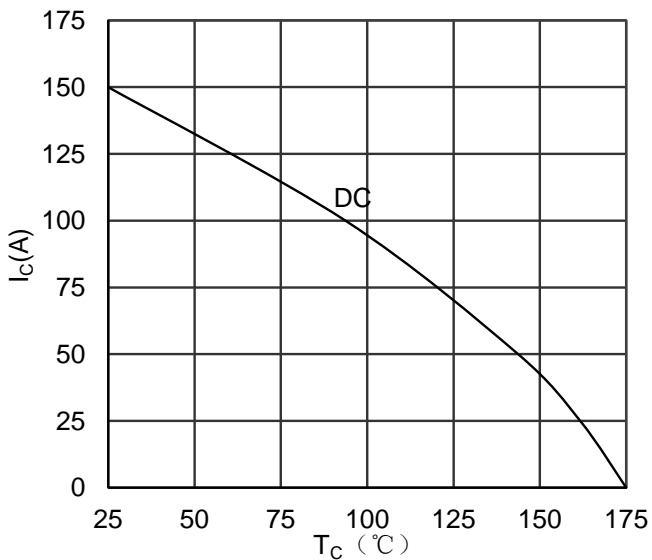

Figure 7. Collector Current vs Case temperature IGBT

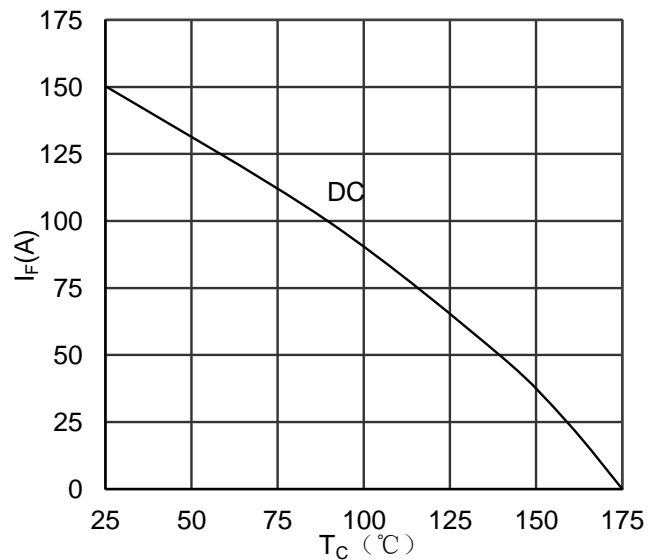

Figure 8. Forward current vs Case temperature Diode

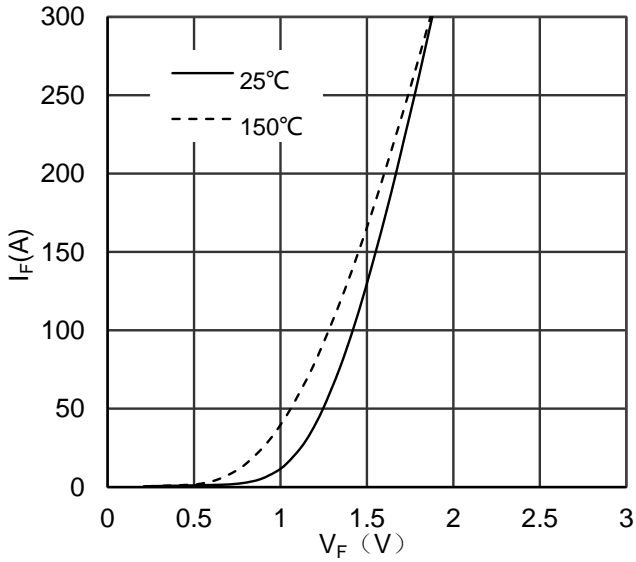

Figure 9. Diode Forward Characteristics Diode

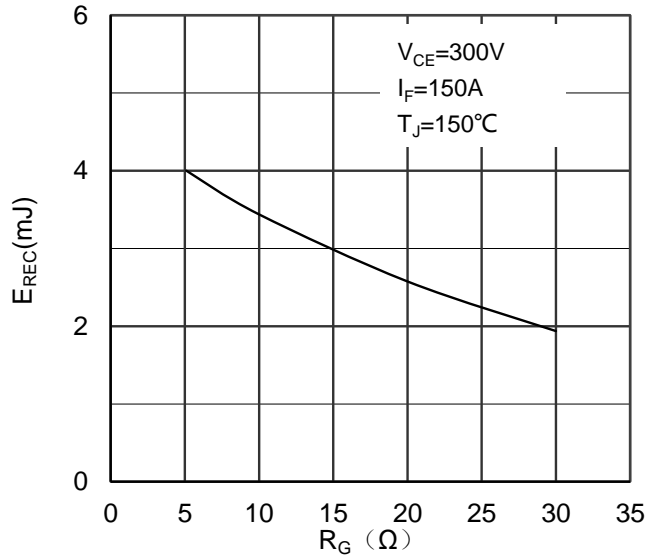

Figure 10. Switching Energy vs Gate Resistor Diode

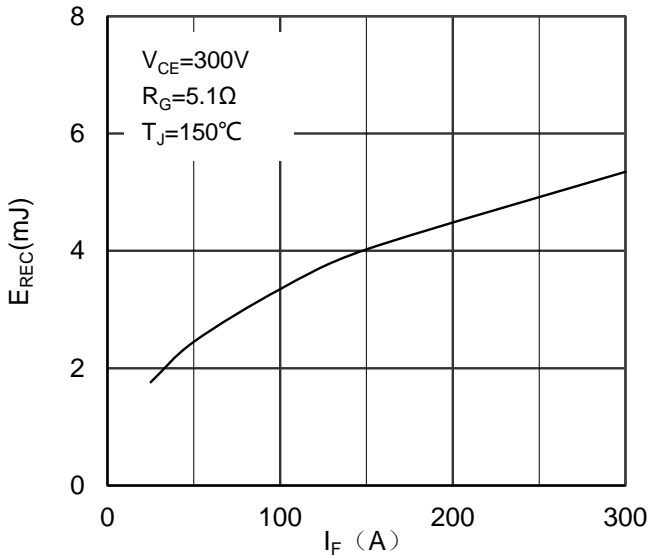

Figure 11. Switching Energy vs Forward Current Diode

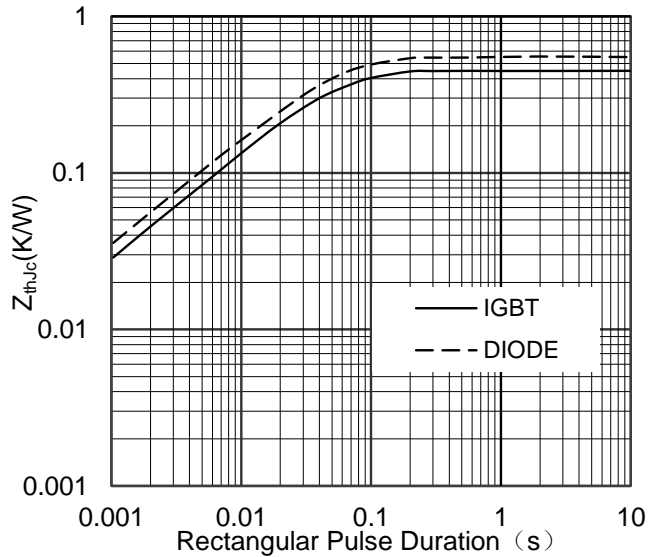

Figure 12. Transient Thermal Impedance of Diode and IGBT

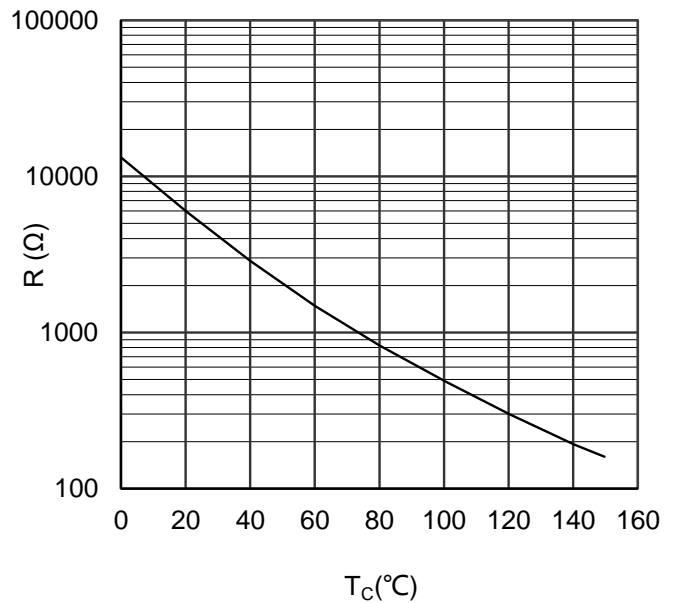

Figure 13. NTC Characteristics

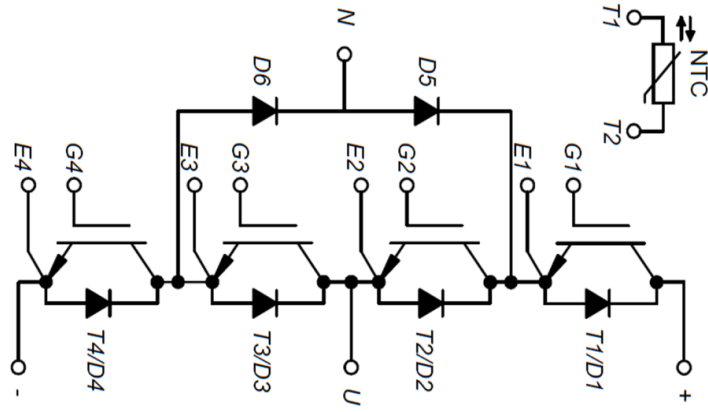
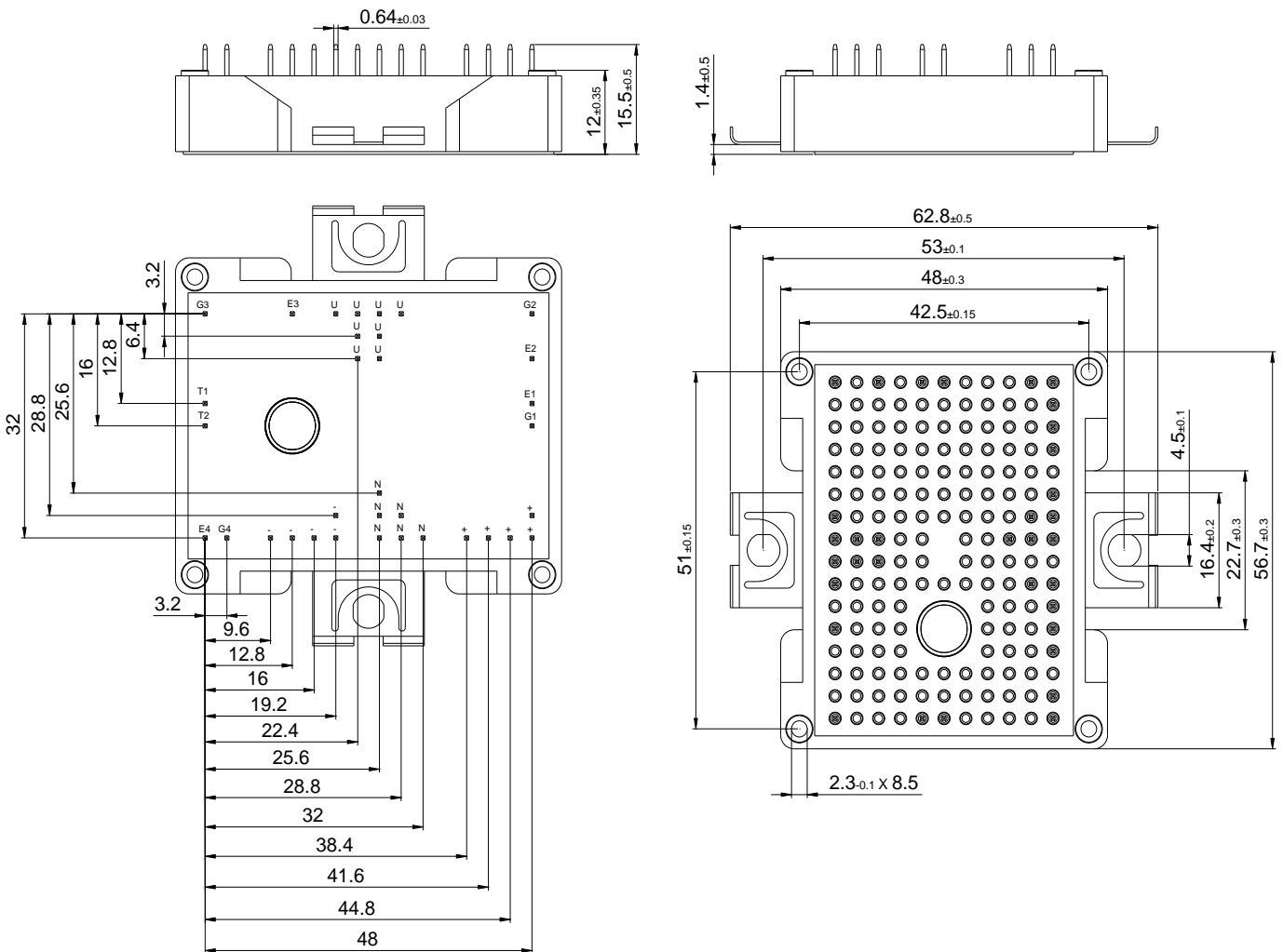

Figure 14. Circuit Diagram



Dimensions in (mm)
Figure 15. Package Outline