

PRODUCT FEATURES

- Low Forward Voltage
- High Surge Current Capability
- Low Leakage Current
- Low Inductance Package

APPLICATIONS

- Field Supply For DC Motors
- Line Rectifiers For Transistorized AC Motor Controllers
- Non-controllable Rectifiers For AC/DC Converter

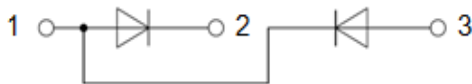

Module Type

Module Type	Circuit Diagram	V_{RRM} (Repetitive Peak Reverse Voltage)	V_{RSM} (Non-Repetitive Peak Reverse Voltage)	Unit
	B			
	MMD90A160B	1600	1700	V

ABSOLUTE MAXIMUM RATINGS($T_C=25^{\circ}C$ unless otherwise specified)

Symbol	Parameter/Test Conditions		Values	Unit
$I_{F(AV)}$	Average Forward Current	Single phase, half wave, 180°conduction, $T_C=85^{\circ}C$	90	A
$I_{F(RMS)}$	R.M.S. Forward Current		141	
I_{FSM}	Non-Repetitive Surge Forward Current	1/2 cycle, 50HZ, peak value, $T_J=45^{\circ}C$	2000	
		1/2 cycle, 60HZ, peak value, $T_J=45^{\circ}C$	2200	
I^2t	For Fusing	1/2 cycle, 50HZ, peak value, $T_J=45^{\circ}C$	20	KA ² S
		1/2 cycle, 60HZ, peak value, $T_J=45^{\circ}C$	20.1	
P_D	Power Dissipation		310	W
T_J	Junction Temperature		-40 to +150	°C
T_{STG}	Storage Temperature Range		-40 to +125	°C
V_{ISO}	Isolation Breakdown Voltage	AC, 50Hz(R.M.S), t=1minute	3000	V
Torque	Module to Sink	Recommended (M6)	3~5	Nm
Torque	Module Electrodes	Recommended (M5)	2.5~5	Nm
R_{thJC}	Junction to Case Thermal Resistance(per diode)		0.4	K/W
Weight			110	g

MacMic Science & Technology Co., Ltd.

Add: #18, Hua Shan Zhong Lu, New District, Changzhou City, Jiangsu Province, P. R. of China

MMD90A160B

ELECTRICAL CHARACTERISTICS ($T_C=25^\circ\text{C}$ unless otherwise specified)

Symbol	Parameter/Test Conditions	Min.	Typ.	Max.	Unit
I_{RM}	Maximum Reverse Leakage Current	$V_R = V_{RRM}$		0.5	mA
		$V_R = V_{RRM}, T_J = 125^\circ\text{C}$		10	
V_F	Forward Voltage Drop			1.6	V
V_{TO}	For power loss calculations only, $T_J = 125^\circ\text{C}$			0.85	V
r_T				2.9	m Ω

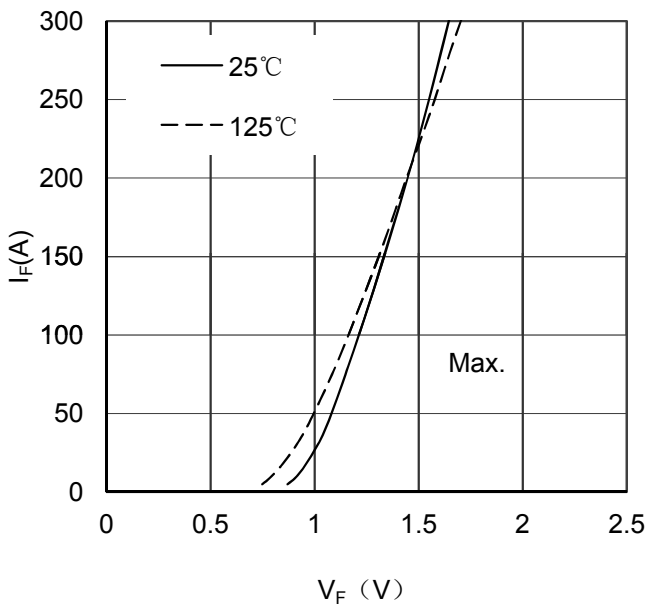

Figure 1. Forward Voltage Drop vs Forward Current

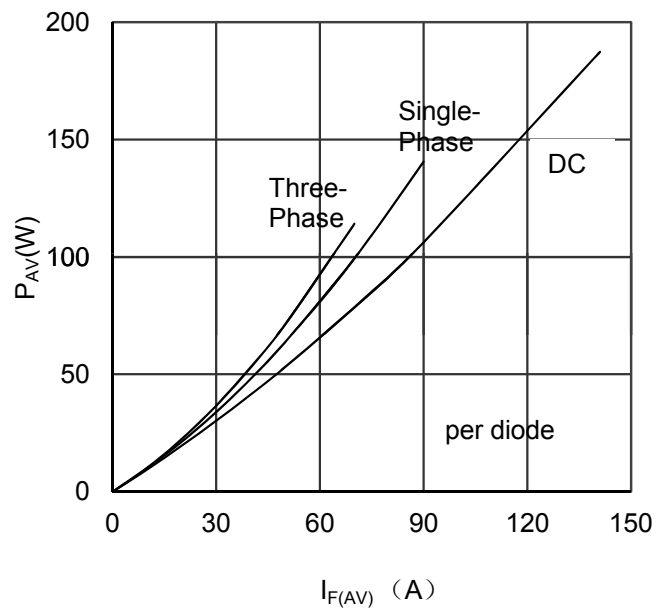

Figure 2. Power dissipation vs $I_{F(AV)}$

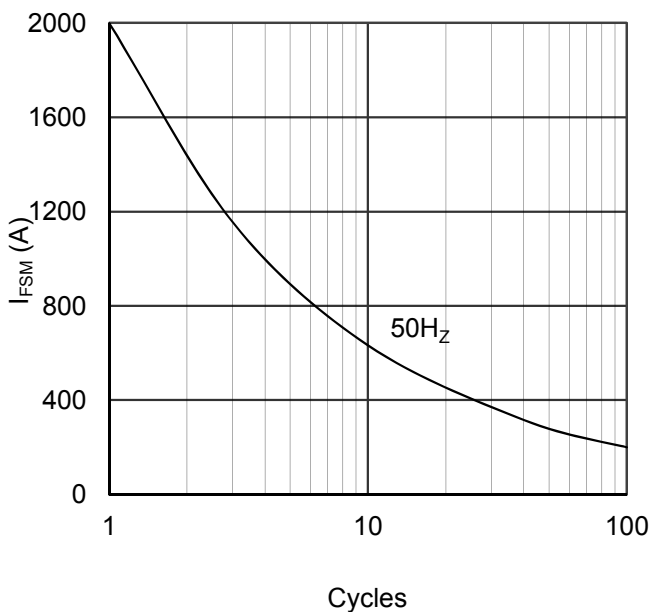

Figure 3. Max Non-Repetitive Forward Surge Current

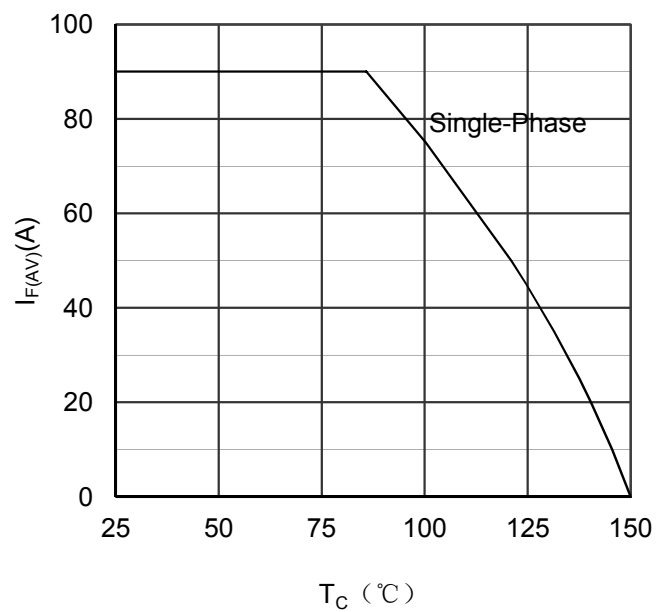
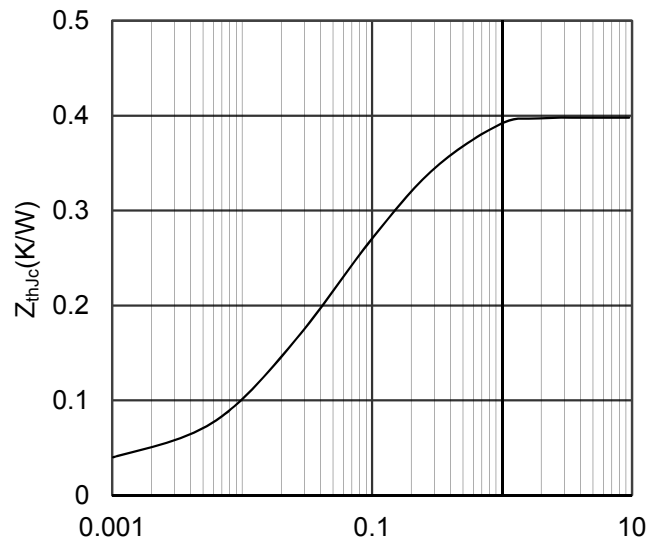
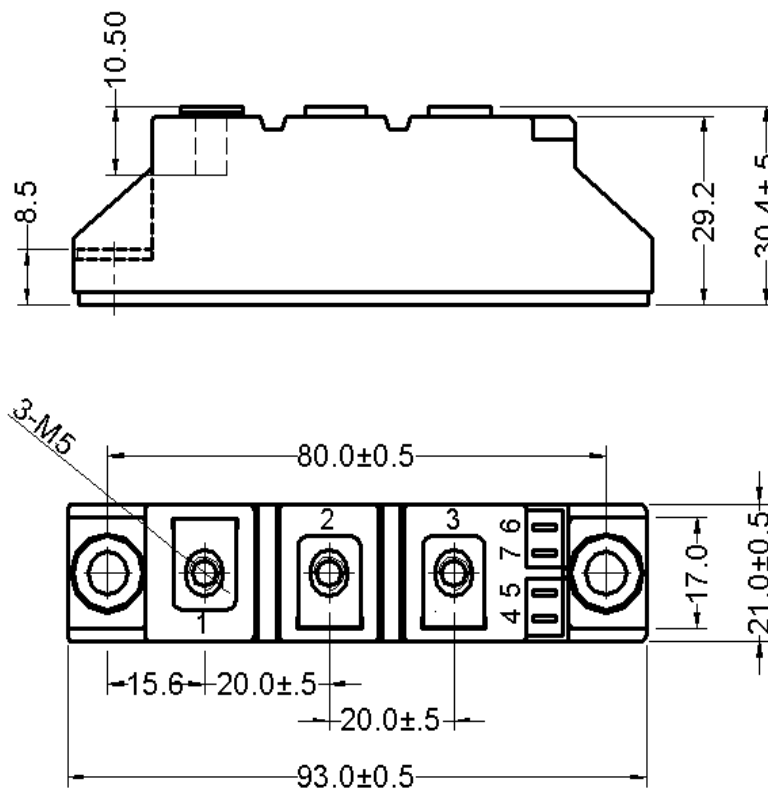

Figure 4. Average Forward Current vs Case temperature



Rectangular Pulse Duration(S)
Figure 5. Transient Thermal Impedance



Dimensions in (mm)
Figure 6. Package Outline